

TREVI MULTI 6

A grand statement of graphic precision, the Multi-arm Trevi is a series of satin brass or bronze arms arranged to illuminate a larger space and can be scaled to fit any interior.

FINISH

240V:
satin brass with matt opal glass shades
TREPE6SBMO-240

bronze with matt opal glass shades
TREPE6BZMO-240

110V:
satin brass with matt opal glass shades
TREPE6SBMO-110

bronze with matt opal glass shades
TREPE6BZMO-110

SUSPENSION

drop rod with ceiling box

please specify the required overall drop from the ceiling to the bottom of the fitting

BULBS

240v - 6 x E14, 25w max (or 4.5w LED 2700k)

110v - 6 x E12, 25w max (or 4.5w LED 2700k)
(no bulbs supplied)

WEIGHT

7kg (15.5lbs)

CERTIFICATION

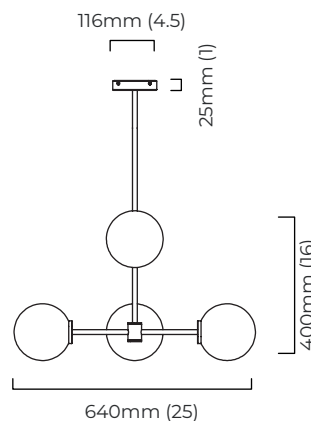
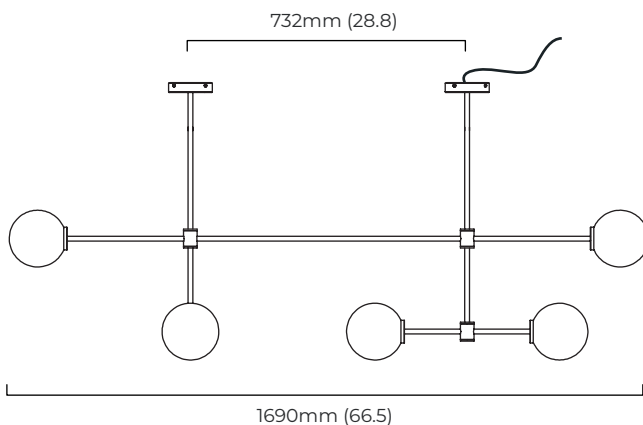
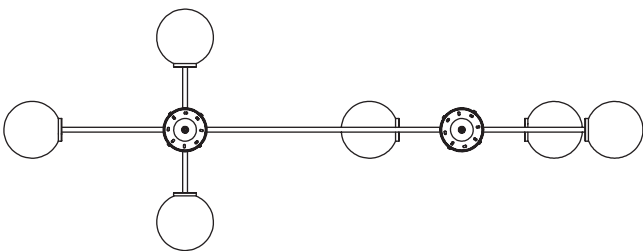

mounting plate dimensions

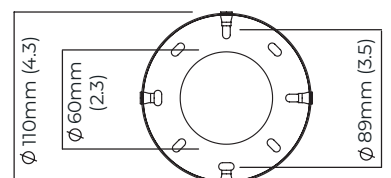

TREVI MULTI 10

A grand statement of graphic precision, the Multi-arm Trevi is a series of satin brass or bronze arms arranged to illuminate a larger space and can be scaled to fit any interior.

FINISH

240V:
satin brass with matt opal glass shades
TREPE1SBMO-240

bronze with matt opal glass shades
TREPE1BZMO-240

110V:
satin brass with matt opal glass shades
TREPE1SBMO-110

bronze with matt opal glass shades
TREPE1BZMO-110

SUSPENSION

drop rod with ceiling box

please specify the required overall drop from the ceiling to the bottom of the fitting

BULBS

240v - 10 x E14, 25w max (or 4.5w LED 2700k)

110v - 10 x E12, 25w max (or 4.5w LED 2700k)
(no bulbs supplied)

WEIGHT

9.5kg (21lbs)

CERTIFICATION

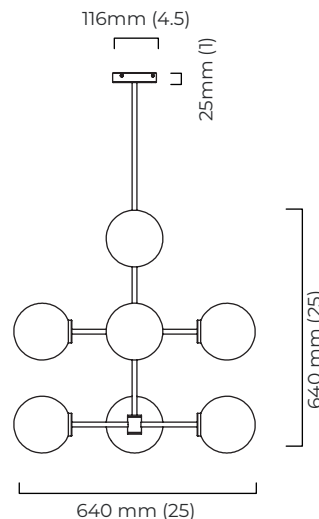
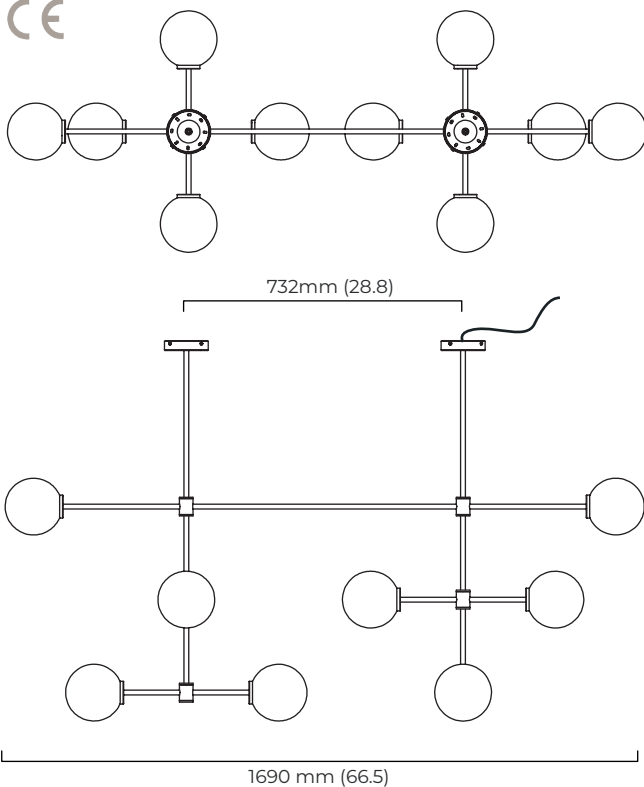
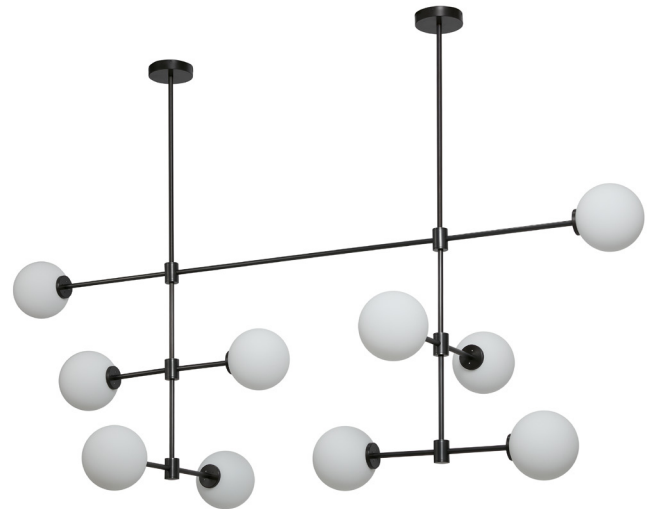

mounting plate dimensions

