

Artemide®

Tolomeo Micro

design
M. De Lucchi
G. Fassina

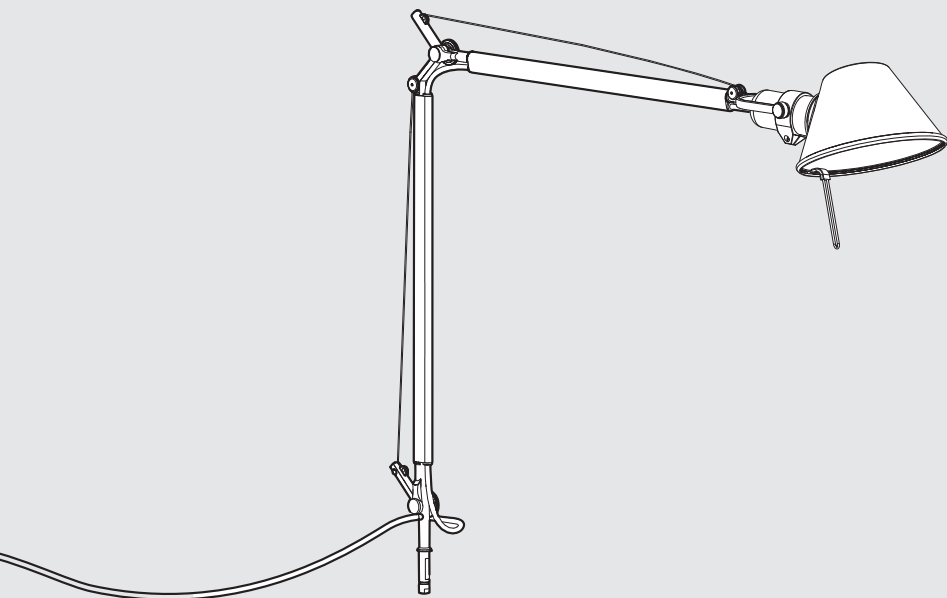



i

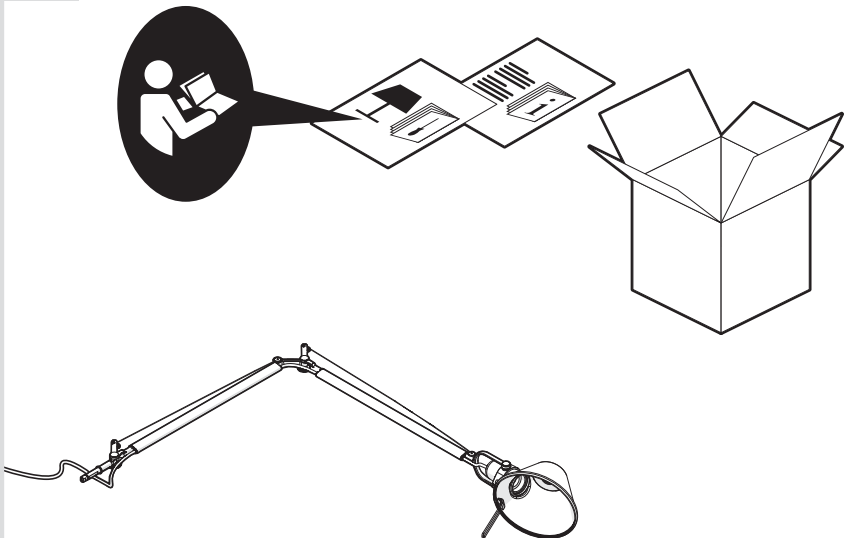
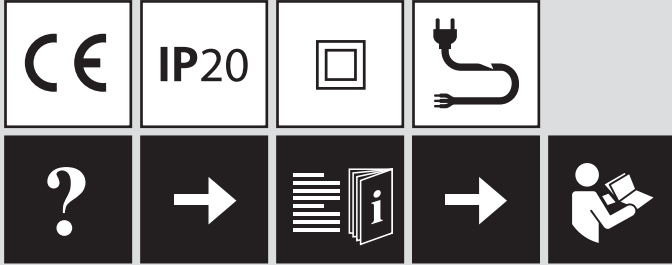

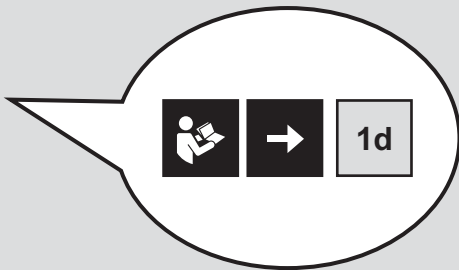
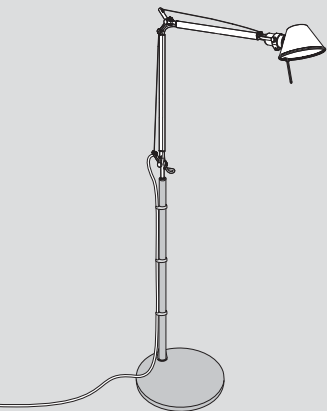
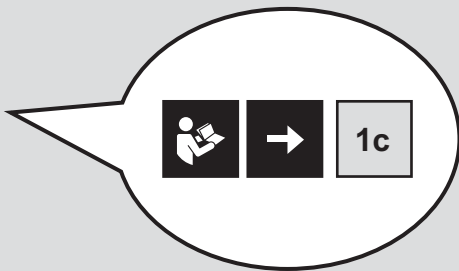
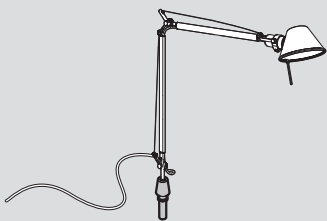
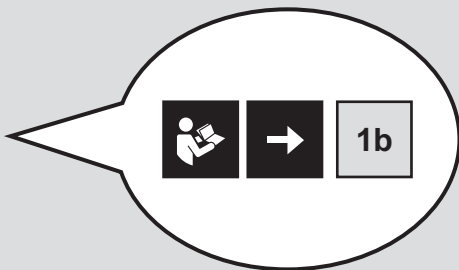
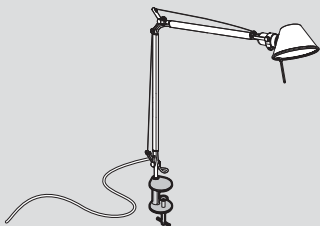
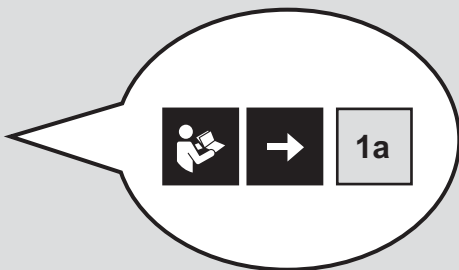
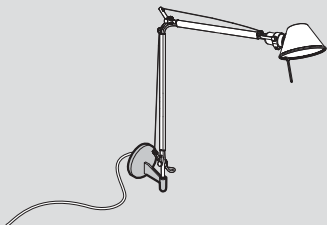

i

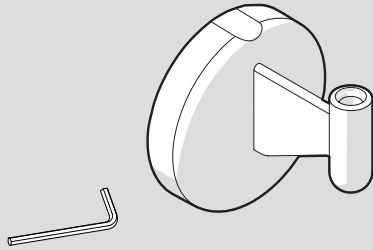

1a

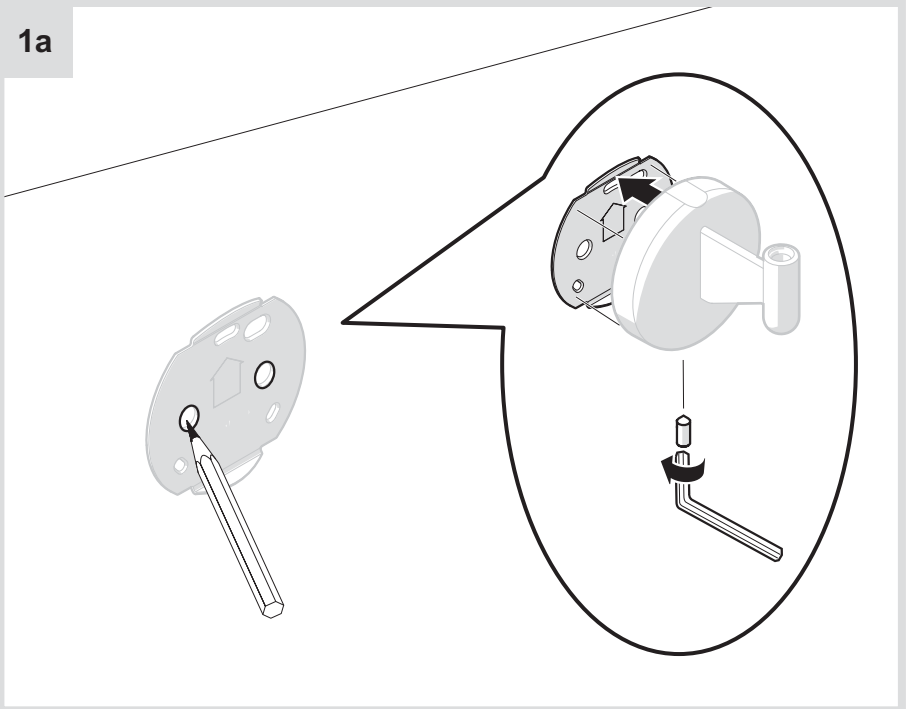

2a

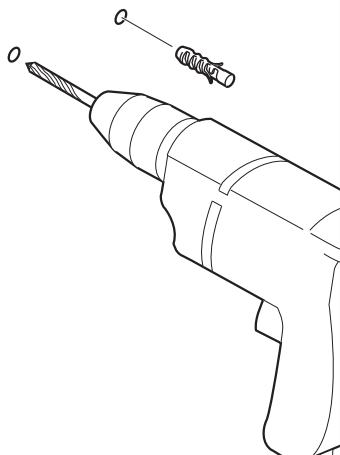

3a

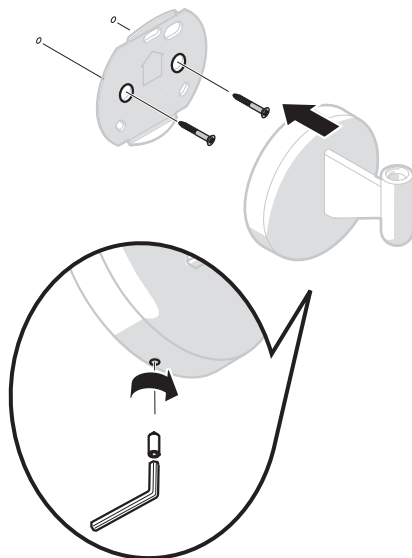

4a

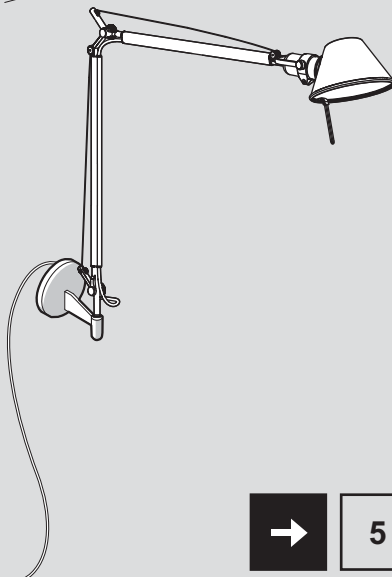

5

i

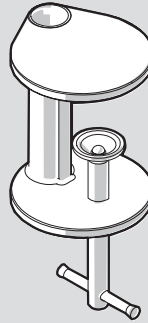

1b

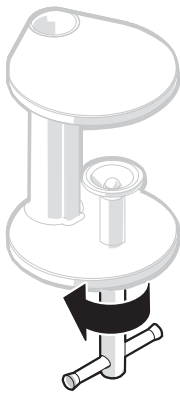

2b

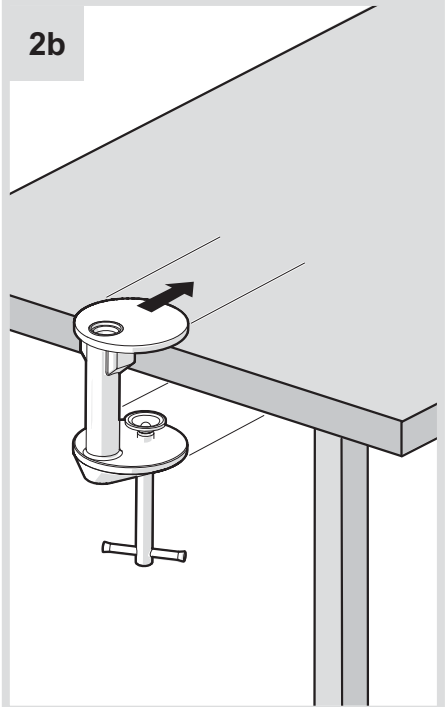

3b

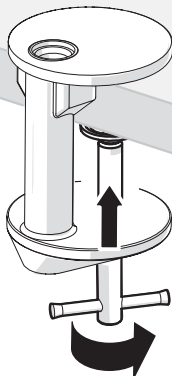

4b

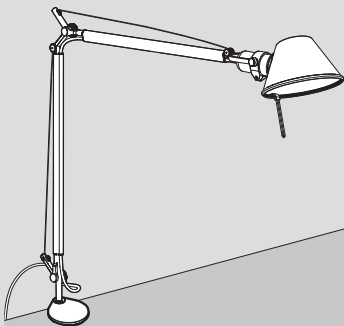

5

i

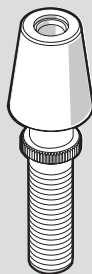

1c

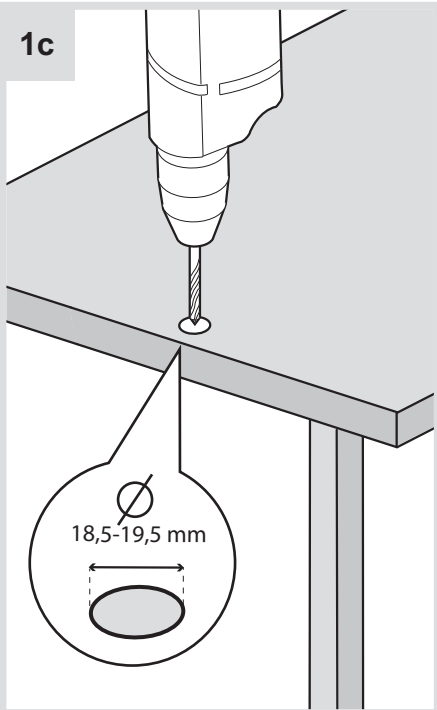

2c

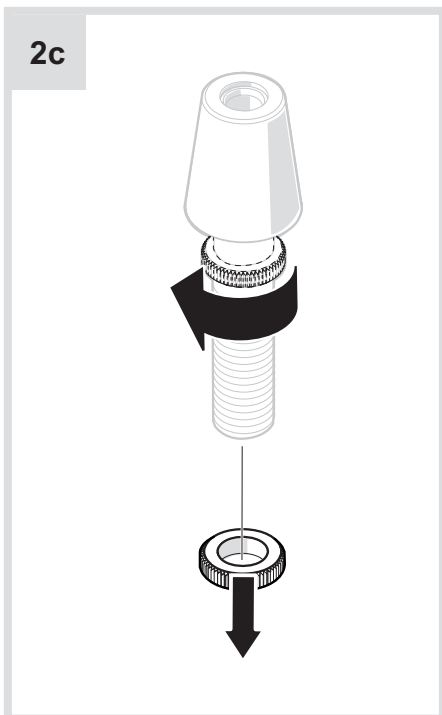

3c

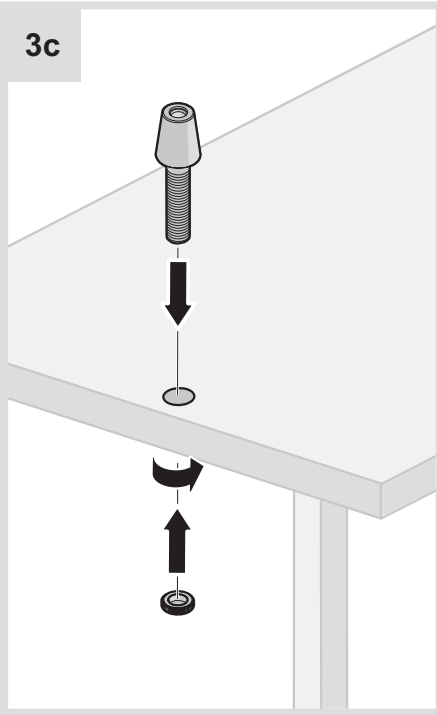

4c

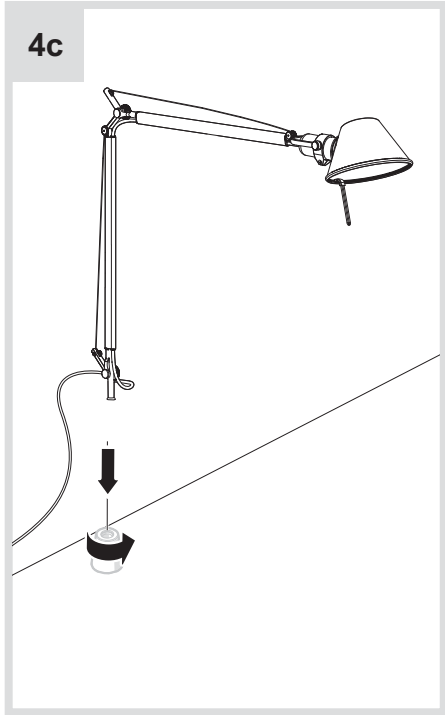

5

i

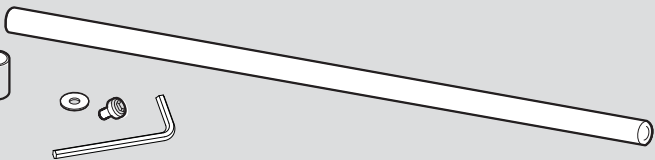
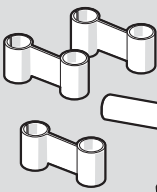
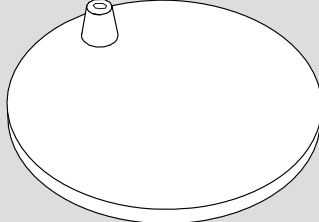

1d

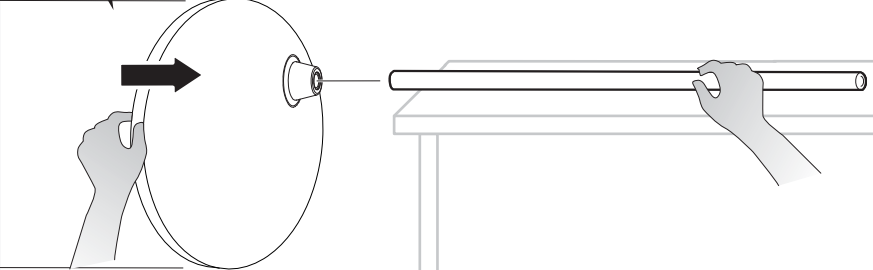
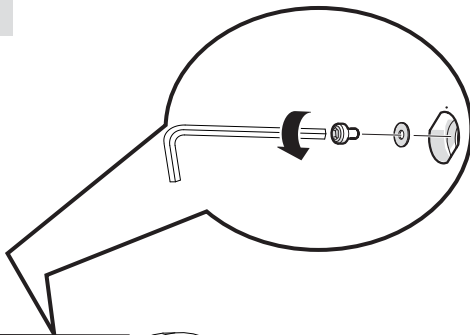

2d

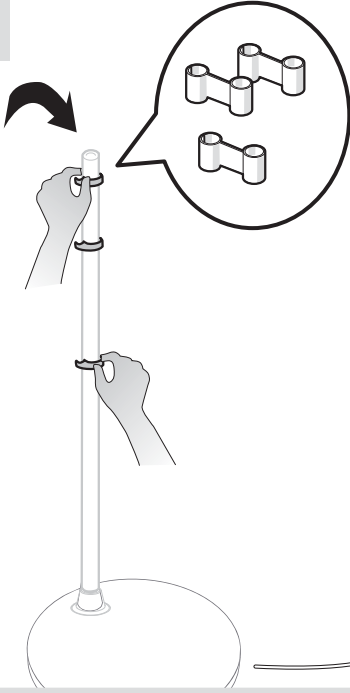

3d

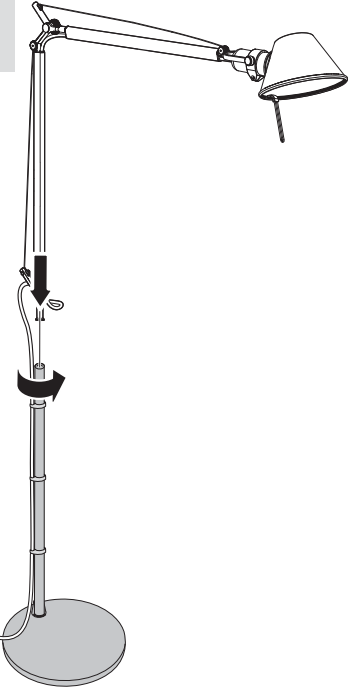

4d

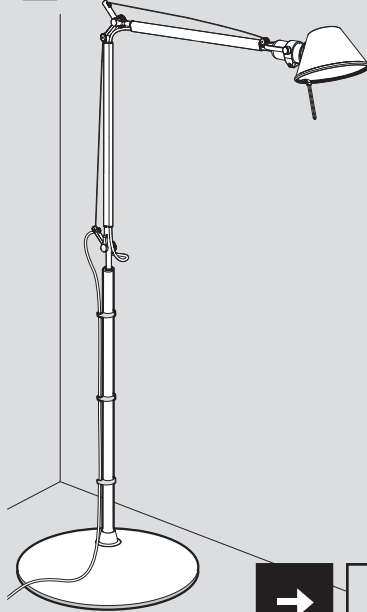
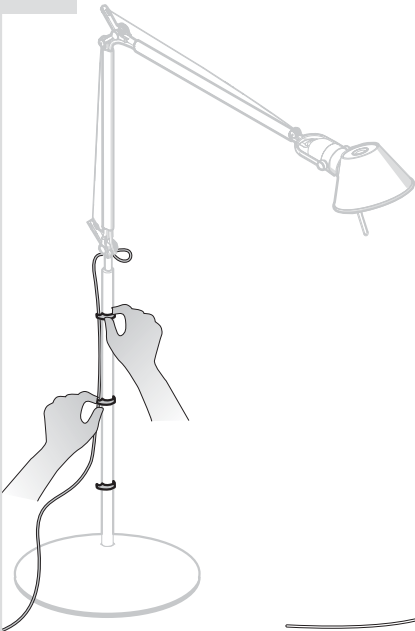

5



5

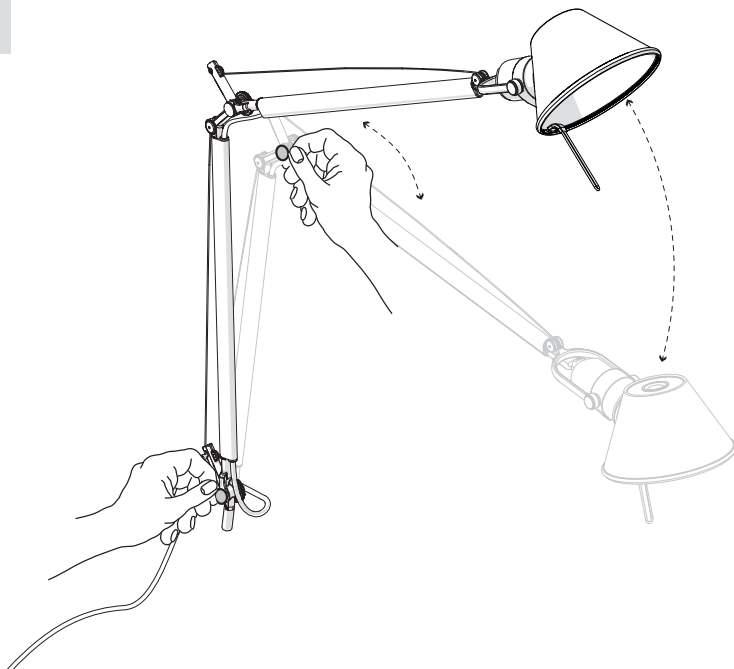

i

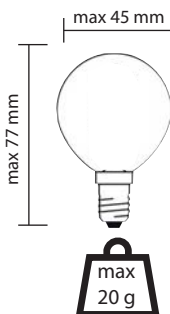
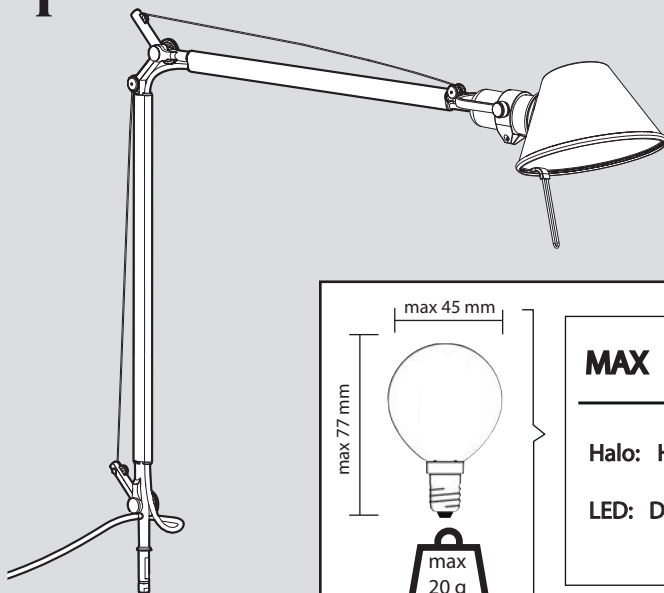

MAX 46W - E14

Halo: HSG - 700 lm

LED: DRBP - 400 lm

i

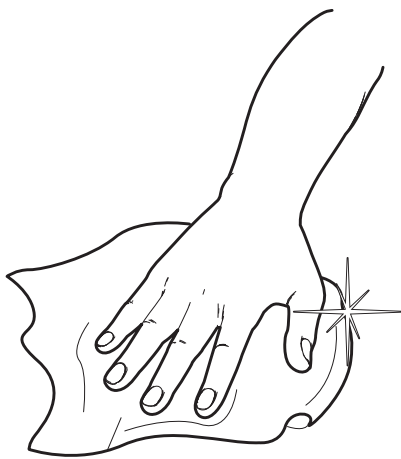
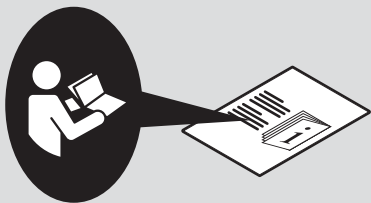

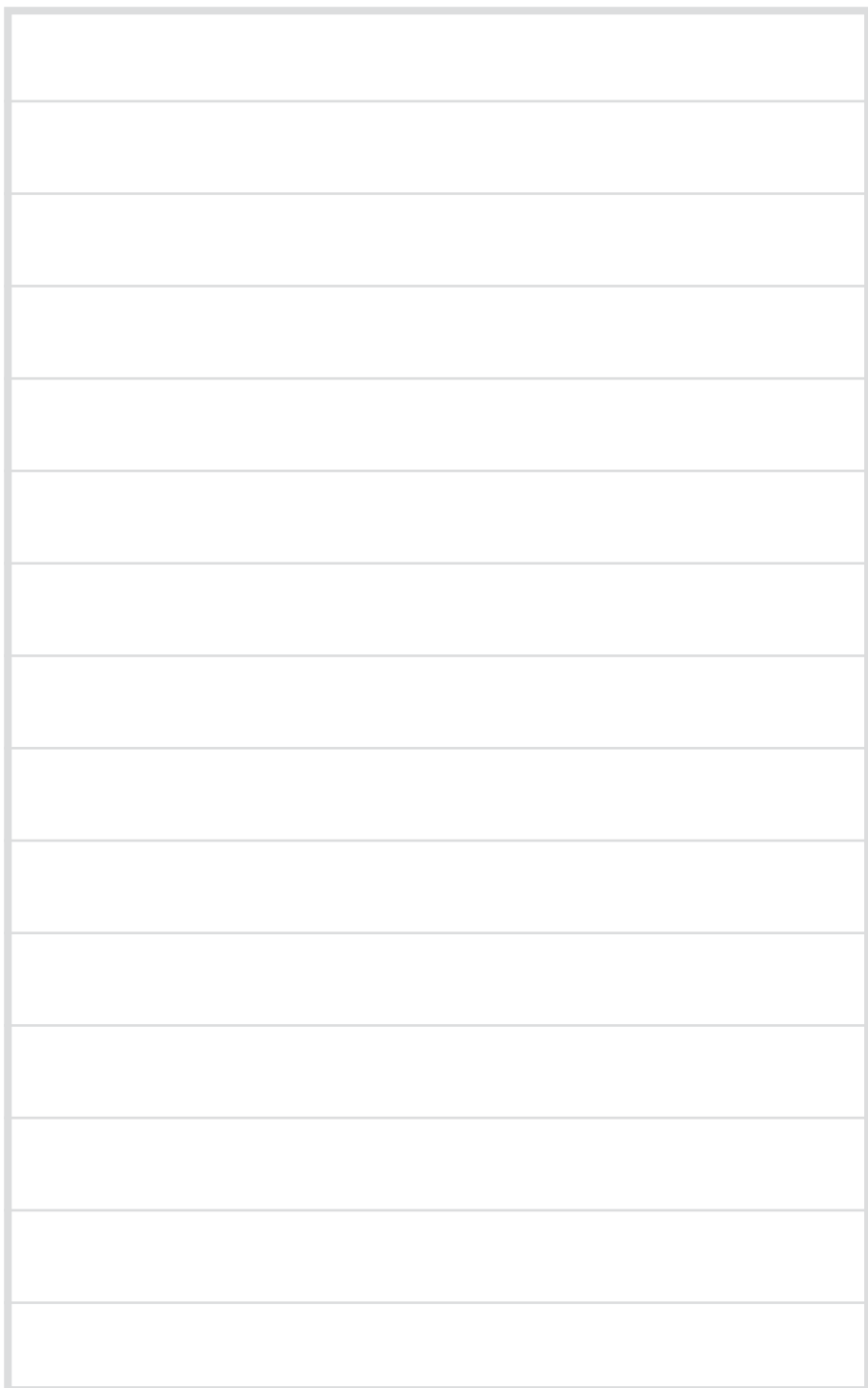

Artemide®



Artemide

via Bergamo, 18
20010 Pregnana M.se (MI)
ITALIA

tel. +39 02 935 181
fax +39 02 935 90 254
fax +39 02 935 90 496

www.artemide.com

VAT IT00846890150

cod. Y513000597

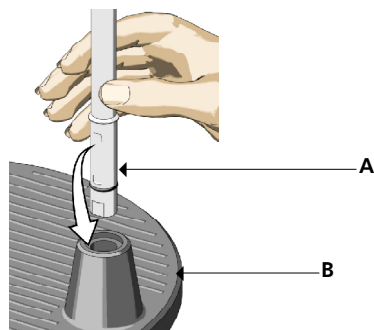

Fig. 1

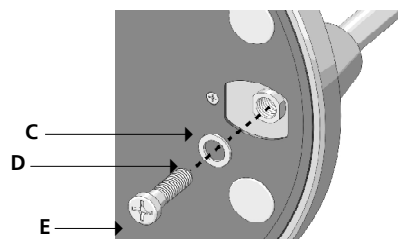

Fig. 2

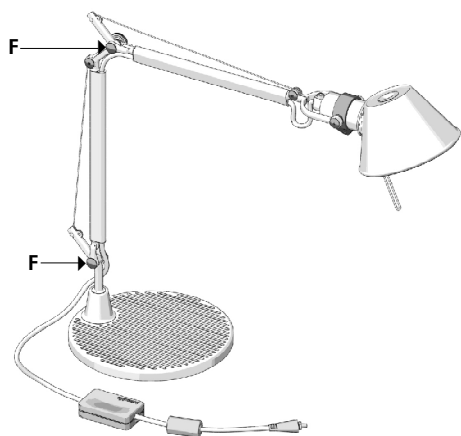

Fig. 3

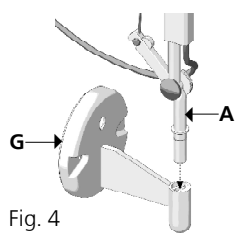

Fig. 4

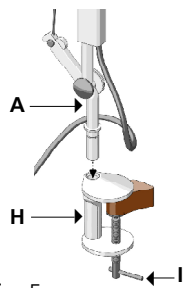

Fig. 5

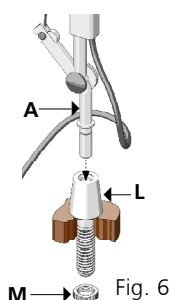

Fig. 6

AVVERTENZE

Prima di ogni operazione sull'apparecchio, disinserire la tensione di rete. L'apparecchio non può essere alimentato da presa comandata dimmerabile.

ISTRUZIONI BASE TAVOLO: Inserire il corpo lampada **A** nella base **B** (fig.1). Capovolgere la base **B**, posizionare la boccia **C**, la rondella **D** e bloccare con la vite **E** (fig.2). Agire sulle due ghiera **F** per aumentare o diminuire la rigidità dell'apparecchio (fig.3).

ISTRUZIONI PARETE (fig.4): Fissare a muro il supporto **G**. Inserire il corpo lampada **A** nell'apposita sede eseguendo una rotazione e una pressione verso il basso.

ISTRUZIONI MORSETTO (fig.5): Fissare il morsetto **H** mediante la vite **I**. Inserire il corpo lampada **A** nell'apposita sede eseguendo una rotazione e una pressione verso il basso.

ISTRUZIONI TAVOLO FISSO (fig.6): Praticare un foro (diametro 18,5-19,5 mm) nel piano prescelto, inserire il supporto **L** e bloccare la ghiera **M**. Inserire il corpo lampada **A** nell'apposita sede eseguendo una rotazione e una pressione verso il basso.

AVIS

Déconnecter la tension de réseau avant toute opération sur l'appareil. L'appareil ne peut pas être alimenté par une prise commandée avec gradateur de lumière.

INSTRUCTIONS BASE TABLE: Insérer le corps de la lampe **A** dans la base **B** (fig.1). Renverser la base **B**, positionner la douille **C**, la rondelle **D** et visser la vis **E** (fig.2). Agir sur les deux bagues **F** pour augmenter ou diminuer la rigidité de l'appareil (fig. 3).

INSTRUCTIONS MUR (fig. 4): Fixer au mur le support **B**. Insérer le corps de l'appareil **A** dans son logement en effectuant une rotation et en exerçant une pression vers le bas.

INSTRUCTIONS ETAU (fig. 5): Fixer l'étau **H** au moyen de la vis **I**. Introduire le corps de l'appareil **A** dans son logement en effectuant une rotation et en exerçant une pression vers le bas.

INSTRUCTIONS TABLE FIXE (fig. 6): Percer un trou (diamètre 18,5-19,5mm) sur la surface choisie, introduire le support **L** et bloquer l'embout **M**. Insérer le corps de l'appareil **A** dans son logement en effectuant une rotation et en exerçant une pression vers le bas.

WARNING

Before any operation on the fixture, disconnect the power supply. The fixture can not be supplied by an outlet provided with dimmer.

TABLE BASE INSTRUCTIONS: Insert fixture body **A** into base **B** (fig.1). Turn base **B** upside down, position bush **C**, washer **D** and lock with screw **E** (fig.2). Act on two ring nuts **F** to increase or decrease the stiffness of the fixture (fig. 3).

WALL INSTRUCTIONS (fig. 4): Fix support **G** to the wall. Insert fixture body **A** into the proper seat by rotating and pressing it downward.

HOLDFAST INSTRUCTIONS (fig. 5): Fix clamp **H** by means of screw **I**. Insert fixture body **A** into the proper seat by rotating and pressing it downward.

FIXED TABLE INSTRUCTIONS (fig. 6): Make a hole (diameter 18.5-19.5mm) in the chosen flat surface, insert support **L** and lock ring nut **M**. Insert fixture body **A** into the proper seat by rotating and pressing it downward. N.B.: Do not use nuts and bolts supplied with the base.

VORSICHT

Vor jedem Eingriff an dem Gerät die Netztension unterbrechen. Das Gerät kann nicht durch eine gesteuerte Steckdose mit Dimmer versorgt werden.

ANLEITUNGEN BASIS TISCH: Den Beleuchtungskörper **A** in die Basis **B** einstecken (Abb.1). Die Basis **B** umkehren, die Buchse **C**, die Unterlegscheibe **D** positionieren und die gelieferte Schraube **E** an dem Lampenkörper anschrauben (Abb. 2). Die zwei Ringe **F** drehen, um die Starrheit des Gerät zu steigern oder verringern (Abb.3).

ANLEITUNGEN WANDLEUCHE (Abb. 4): Die Halterung **G** und der Wand befestigen. Den Beleuchtungskörper **A** in die geeigneten Sitz beim Drehen und Drücken nach unten einsetzen.

ANLEITUNGEN KLEMMENLEUCHE (Abb. 5): Die Klemme **H** durch die Schraube **I** befestigen. Den Beleuchtungskörper **A** in die geeigneten Sitz beim Drehen und Drücken nach unten einsetzen.

ANLEITUNGEN FESTE TISCHLEUCHE (Abb. 6): Die Tischplatte kreisförmig ausbohren (Durchmesser 18,5-19,5mm), die Halterung **L** einstecken und mit Nutmutter **M** festziehen. Den Beleuchtungskörper **A** in die geeigneten Sitz beim Drehen und Drücken nach unten einsetzen.

ADVERTENCIAS

Antes de efectuar cualquier operación, desconectar la tensión de red. El aparato no puede ser alimentado por una toma mandada con regulador de luz.

INSTRUCCIONES BASE MESA: Introducir el cuerpo lámpara **A** en la base **B** (fig.1). Volcar la base **B**, poner el casquillo **C** la arandela **D** y atornillar el tornillo **E** entregado con el cuerpo lámpara (fig.2). Mediante las dos abrazaderas **F** aumentar o disminuir la rigidez del aparato (fig. 3).

INSTRUCCIONES PARED (fig. 4): Fijar a la pared el soporte **G**. Introducir el cuerpo lámpara **A** en el espacio correspondiente efectuando una rotación y una presión hacia abajo.

INSTRUCCIONES MORDAZA (fig. 5): Ajustar la mordaza **H** mediante el tornillo **I**. Introducir el cuerpo lámpara **A** en el espacio correspondiente efectuando una rotación y una presión hacia abajo.

INSTRUCCIONES MESA FIJA (fig. 6): Hacer un agujero (diámetro 18,5-19,5mm) en la superficie establecida, introducir el soporte **L** y bloquear la virola **M**. Introducir el cuerpo lámpara **A** en el espacio correspondiente efectuando una rotación y una presión hacia abajo.

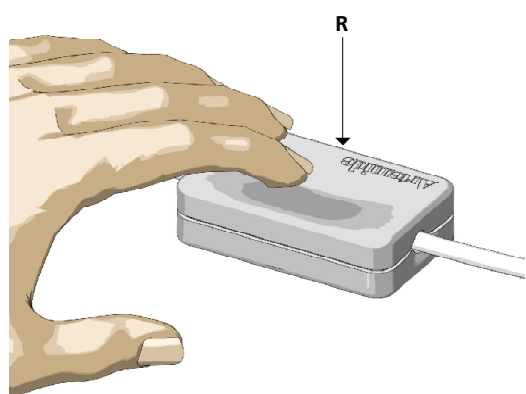
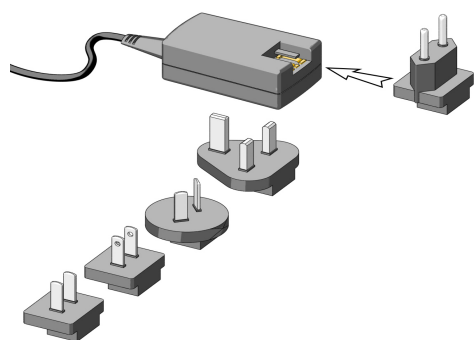
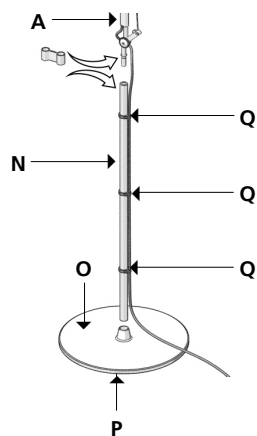

- I ISTRUZIONI TERRA:** Inserire l'asta **N** nella base **O** e bloccare con la rondella e la vite **P**. Posizionare i tre reggifilo **Q** sull'asta **N**. Inserire il corpo lampada **A** nell'apposita sede eseguendo una rotazione e una pressione verso il basso. Far passare il cavo di alimentazione nei reggifilo **Q**.
- F INSTRUCTIONS TERRE:** Insérer la tige **N** dans la base **O** et bloquer à l'aide de la rondelle et de la vis **P**. Positionner les trois supports du câble **Q** sur la tige **N**. Insérer le corps de l'appareil dans son logement en effectuant une rotation et en exerçant une pression vers le bas. Faire passer le câble d'alimentation dans les supports du câble **Q**.
- EN FLOOR INSTRUCTIONS:** Insert stem **N** into base **O** and lock it by means of the washer and screw **P**. Position the three wire holders **Q** on stem **N**. Insert lamp body **A** into its seat by rotating and pressing downwards. Make the feeding cable go through wire holders **Q**.
- D ANLEITUNGEN ERDE:** Den Stab **N** in die Basis **O** einstecken und sie durch die Scheibe und die Schraube **P** befestigen. Die drei Drahthalter **Q** auf den Stab **N** positionieren. Den Lampenkörper **A** in seinen Sitz beim Drehen und Drücken unterwärts einstecken. Das Speisekabel durch die Drahthalter **Q** einführen.
- E INSTRUCCIONES SUELO:** Introducir la varilla **N** en la base **O** y bloquear con la arandela y el tornillo **P**. Poner los tres soportes del cable **Q** en la varilla **N**. Introducir el cuerpo lámpara **A** en el alojamiento adecuado con una rotación y una presión hacia abajo. Hacer pasar el cable de alimentación en los soportes del cable **Q**.

I
ATTENZIONE: Dotare il trasformatore dell'apposito adattatore a spina. Prima di collegare il trasformatore alla presa di corrente, verificare che la tensione nominale marcata sullo stesso sia uguale a quella disponibile in rete. Non è ammesso alcun tipo di abbinamento fra apparecchi e trasformatori/sistemi di alimentazione diversi da quelli definiti da ARTEMIDE.

FUNZIONAMENTO: L'apparecchio è dotato di un dimmer per la regolazione dell'intensità luminosa. L'accensione avviene tramite un breve tocco nella parte centrale dell'interruttore **R** posto sul cavo di alimentazione. Tenere premuto l'interruttore **R** per regolare l'intensità luminosa sino al livello desiderato o sino al livello massimo. Una seconda pressione prolungata dell'interruttore **R** inverte il senso di regolazione dell'intensità luminosa verso il minimo. Spegner l'apparecchio agendo sull'interruttore **R** con un breve tocco. Alla riaccensione l'apparecchio riproduce la stessa intensità di luce impostata prima dello spegnimento.

F
ATTENTION: Equiper le transformateur de l'adaptateur fiche adéquat. Avant de connecter le transformateur à la prise de courant, vérifier que la tension nominale marquée sur le transformateur lui-même soit pareille à celle disponible dans le réseau. Aucun type de connexion entre les appareils et les transformateurs/systèmes d'alimentation différents de ceux indiqués par ARTEMIDE n'est admis.

FONCTIONNEMENT: L'appareil est pourvu d'un gradateur de lumière pour le réglage de l'intensité lumineuse. L'allumage se produit en touchant brièvement la partie centrale de l'interrupteur **R** placé sur le câble d'alimentation. Tenir pressé l'interrupteur **R** pour régler l'intensité lumineuse jusqu'au niveau désiré ou au niveau maximum. Une autre pression prolongée de l'interrupteur **R** inverse le sens de réglage de l'intensité lumineuse vers le minimum. Eteindre l'appareil en pressant brièvement l'interrupteur **R**. Lorsque l'appareil est rallumé, il reproduit la même intensité de lumière établie avant de l'éteindre.

EN
WARNING: Provide the transformer with the proper outlet adapter. Before connecting the transformer to the outlet, check that the rated voltage marked on it is the same of the network one. No type of connection between fixtures and transformers/outlets different from the ones defined by ARTEMIDE is allowed.

OPERATION: The fixture is provided with a dimmer for the regulation of the light intensity. To turn the fixture on, just touch the central part of switch **R** located on the feeding cable. Keep pressed switch **R** to regulate the light intensity up to the desired level or up to the maximum level. Another long pressure of switch **R** inverts the regulation direction of the light intensity toward the minimum. Turn the fixture off by acting on switch **R**. When turning the fixture on the same light intensity set before the turning off is produced again.

D
ACHTUNG: Den Transformator mit dem geeigneten Steckeradapter ausrüsten. Vor der Verbindung des Transformators zu der Steckdose prüfen Sie, dass die auf dem Transformator markierte Nennspannung gleich die Leitungsspannung ist. Keine Verbindung zwischen Gerät und Transformator/Steckdose verwenden, die von den jeniger, die von ARTEMIDE bestimmt wird, unterschiedlich ist.

BETRIEB: Das Gerät ist mit einem Dimmer zur Regelung der Lichtstärke ausgerüstet. Der Zentralteil des Schalters **R** auf das Speisekabel kurz drücken, um das Gerät einzuschalten. Den Schalter **R** gedrückt halten, um die Lichtstärke bis zu dem gewünschten Niveau oder zu dem maximalen Niveau zu regeln. Beim zweiten langen Druck des Schalters **R** wird die Richtung der Lichtstärke nach dem Minimum umgekehrt. Das Gerät beim kurzen Druck des Schalters **R** ausschalten. Beim Wiedereinschalten hat das Gerät die selbe Lichtstärke, die vor dem Ausschalten eingestellt war.

E
CUIDADO: Equipar el transformador con el adaptador de enchufe adecuado. Antes de conectar el transformador a la toma de corriente, cerciorarse de que la tensión nominal indicada en el mismo corresponda a la disponible en la red. No se admite ningún tipo de conexión entre aparatos y transformadores/sistemas de alimentación diferentes de los indicados por ARTEMIDE.

FUNCIÓNAMIENTO: El aparato está provisto de un regulador de la intensidad luminosa; para encenderlo, presionar brevemente la parte central del interruptor **R** colocado en el cable de alimentación. Mantener presionado el interruptor **R** para regular la intensidad luminosa hasta el nivel deseado o el nivel máximo. Otra presión prolongada del interruptor **R** invierte el sentido de regulación de la intensidad luminosa hacia el nivel mínimo. Presionar brevemente el interruptor **R** para apagar el aparato. Cuando se enciende nuevamente, el aparato produce la misma intensidad de luz programada antes de su apagamiento.

I

SOSTITUZIONE LED

All'apparecchio è abbinata una sorgente caratterizzata da una elevatissima vita utile. Tuttavia, nel caso fosse necessaria la sostituzione del led, questa dovrà essere effettuata esclusivamente da nostro personale specializzato.

Siete pregati pertanto di rivolgervi al distributore più vicino.

Per gli indirizzi dei distributori Artemide nel mondo, visitate il sito: www.artemide.com.

F

REPLACEMENT LED

Une source avec une vie utile très longue est jointe à l'appareil. De toute façon, au cas où il serait nécessaire de remplacer le led, cette opération devra être effectuée exclusivement par notre personnel spécialisé.

Vous êtes donc priés de vous adresser au distributeur le plus proche.

Pour les adresses des distributeurs Artemide dans le monde, visiter le site: www.artemide.com.

EN

LED REPLACEMENT

The fixture is provided with light source having a long life. Anyway, if the led must be replaced, this operation must be carried out only by our specialized staff.

Therefore, we recommend contacting the nearest dealer.

For the addresses of Artemide dealers in the world, visit our website: www.artemide.com.

D

ERSATZ LED

Das Gerät ist mit einer Lichtquelle ausgerüstet, die eine lange Lebensdauer hat. Falls die LED ersetzt werden sollte, muss der Ersatz nur von unserem spezialisierten Personal ausgeführt werden.

Es wird empfohlen den näher Verteiler zu kontaktieren.

Für die Adressen der Verteiler Artemide in der Welt besuchen Sie unsere Internet-Site: www.artemide.com.

E

SUSTITUCIÓN LED

El aparato funciona con una fuente luminosa de muy larga duración. Sin embargo, una sustitución eventual del led debe ser efectuada exclusivamente por nuestro personal encargado.

En este caso, por lo tanto, contacte con el distribuidor más cercano.

Para encontrar las direcciones de los distribuidores de Artemide en el mundo, visite nuestro sitio: www.artemide.com.



Avvertenze generali apparecchi di illuminazione per interni	Avertissements généraux pour appareils d'éclairage d'intérieur	General warnings for indoor light fittings	Generelle Hinweise für Beleuchtungsgeräte für Innenräume	Advertencias generales para aparatos de iluminación para interior
--	--	---	--	---

Tutti i prodotti **ARTEMIDE** che rientrano nell'ambito di applicazione della direttiva europea bassa tensione B.T. 2006/95/CE e della direttiva europea compatibilità elettromagnetica E.M.C. 2004/108/CE soddisfano i requisiti richiesti e recano la marcatura "CE".

Tous les produits **ARTEMIDE** appartenant au champ d'application de la directive européenne basse tension B.T. 2006/95/CE et de la directive européenne compatibilité électromagnétique E.M.C. 2004/108/CE remplissent les conditions prévues et portent le marquage "CE".



All **ARTEMIDE** products falling within the range of application of the European low voltage directive B.T. 2006/95/CE and of the European electromagnetic compatibility E.M.C. directive 2004/108/EC meet the required specifications and bear "CE" labelling.

Alle Produkte von **ARTEMIDE**, die unter das Anwendungsgebiet der europäischen Richtlinie der Niederspannung B.T. 2006/95/CE und der elektromagnetischen Kompatibilität E.M.C. 2004/108/EG fallen, entsprechen den erforderlichen Eigenschaften und tragen das "CE" Kennzeichen.

Todos los productos **ARTEMIDE** que pertenecen al ámbito de aplicación de la directiva europea baja tensión B.T. 2006/95/CE y de la directiva europea compatibilidad electromagnética E.M.C. 2004/108/CE cumplen los requisitos correspondientes y llevan el marcado "CE".



Gli apparecchi in classe III devono essere alimentati da un trasformatore di sicurezza conforme alle norme vigenti.

Les appareils dans la classe III doivent être alimentés par un transformateur de sécurité conforme aux normes en vigueur.

The fixtures in class III must be supplied with a transformer in compliance with the regulations in force.

Die Geräte in Klasse III müssen durch einen den geltenden Normen entsprechenden Transformator gespeist werden.

Los aparatos de clase III deben ser alimentados por un transformador de seguridad que cumpla con las normas vigentes.

L'apparecchio è stato testato secondo la norma IEC 62471:2006 sicurezza fotobiologica delle lampade – l'apparecchio ricade nel gruppo di rischio: esente

L'appareil a été testé selon la norme IEC 62471:2006 sécurité photobiologique des lampes – l'appareil fait partie dans le groupe de risque: exempt

The fixture has been tested according to the standard IEC 62471:2006 photobiological safety of lamps – the fixture is classified in risk group: exempt

Das Gerät wurde nach der Norm IEC 62471:2006 photobiologische Sicherheit von Lampen getestet – das Gerät fällt unter die Freie Gruppe

El aparato ha sido ensayado según lo previsto por la norma IEC 62471:2006 seguridad fotobiológica de las lámparas – el aparato pertenece al grupo de riesgo: exento.

ARTEMIDE s.p.a. non si assume alcuna responsabilità per prodotti modificati senza preventiva autorizzazione.

ARTEMIDE spa décline toute responsabilité pour les produits modifiés sans autorisation préalable.

ARTEMIDE spa does not shoulder any responsibilities for products which are modified without prior authorisation.

ARTEMIDE s.p.a. nimmt keine Verantwortung für ohne Voreingehmung geänderte Produkte an.

ARTEMIDE spa no se asume ninguna responsabilidad ante productos modificados sin autorización.

Nel caso si rendesse necessaria la sostituzione del cavo di alimentazione contattare il centro assistenza ARTEMIDE.

Si le cordon d'alimentation doit être remplacé, contacter le service après vente ARTEMIDE.

For the replacement of the power supply cable, please contact ARTEMIDE service centre.

falls es nötig sein sollte das Speisekabel auszuwechseln, das technische Assistenzzentrum ARTEMIDE kontaktieren.

Si fuera necesario sustituir el cable de alimentación, póngase en contacto con el centro de asistencia técnica ARTEMIDE.

Attenzione: la sicurezza elettrica di questo apparecchio è garantita con l'uso appropriato di queste istruzioni. Pertanto è necessario conservarle.

Attention: la sécurité de l'appareil n'est garantie que si les instructions sont convenablement suivies. Il est donc nécessaire de les conserver.

Warning: this equipment is guaranteed only when used as indicated in these instructions. Therefore they should be kept for future reference.

Achtung: die Sicherheit der Leuchte wird nur bei sachgerechtem Gebrauch gemäß Anweisungen gewährleistet. Bitte bewahren Sie diese sorgfältig auf.

Atencion: la seguridad del aparato está garantizada solo con el uso apropiado de las instrucciones. Por lo tanto es necesario conservarlas.

In caso di reclamo citare il numero

En cas de réclamation, veuillez citer le numéro

In case of complaint, please quote number

Bei jeder Reklamation geben Sie, bitte folgende Nummer an

En caso de reclamación indicar el número



Artemide®

Via Bergamo, 18
I-20010 Pregnana M.se (MI) - ITALIA
t. +39 02.935.18.1 f. +39 02.935.90.254-496
info@artemide.com
www.artemide.com

