

Reeds

design
Klaus Begasse

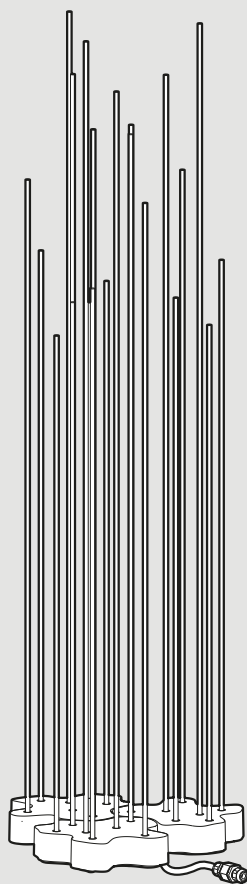

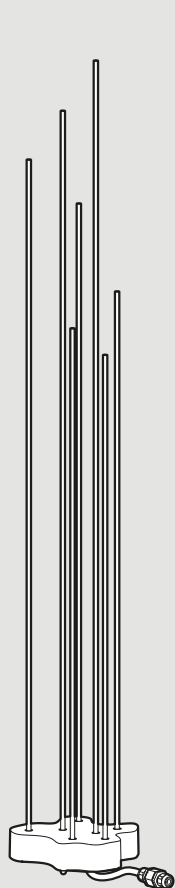

i

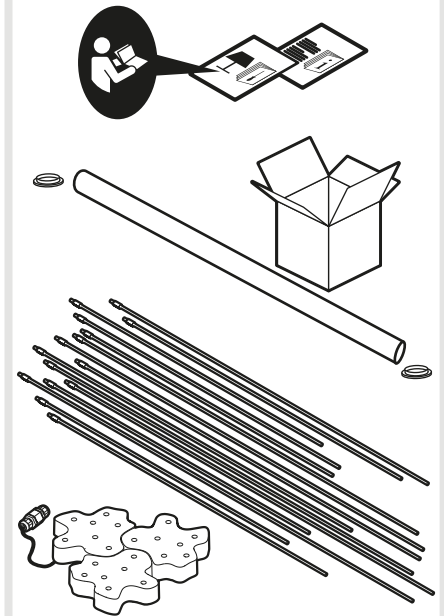
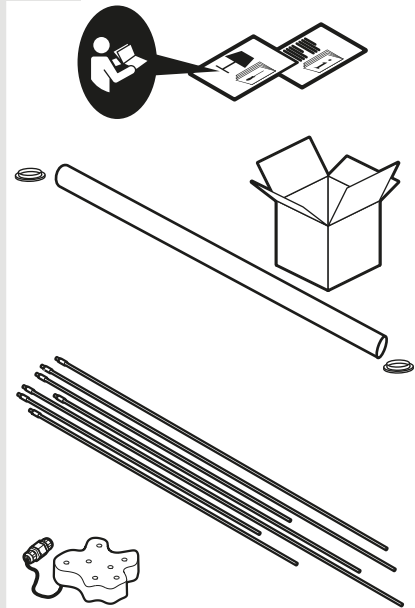
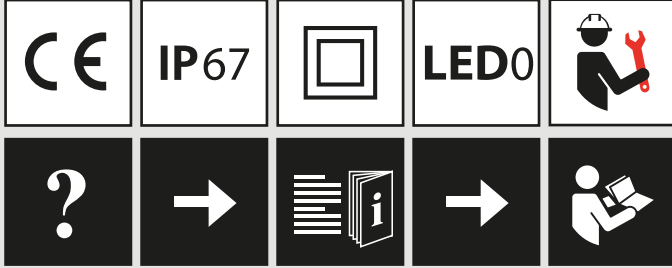

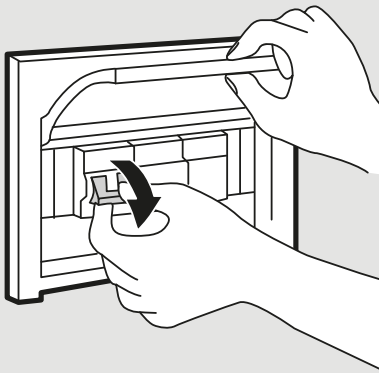

1

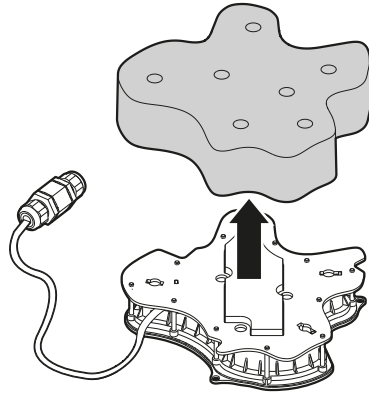

2

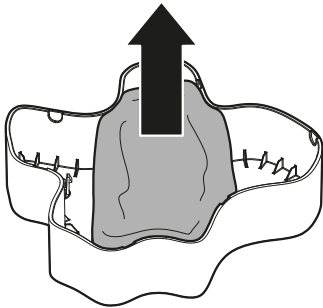

3

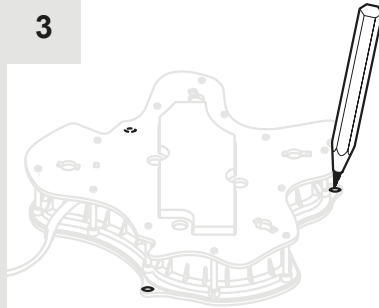

4

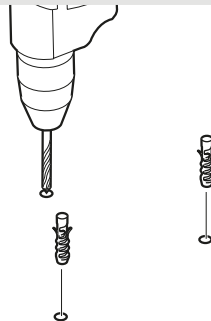

5a

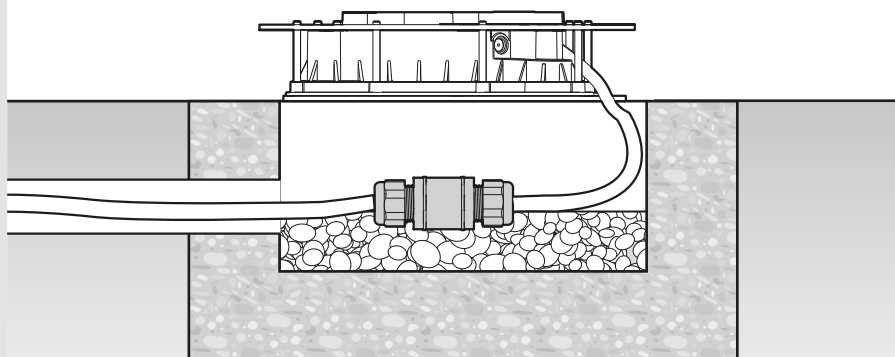

5b

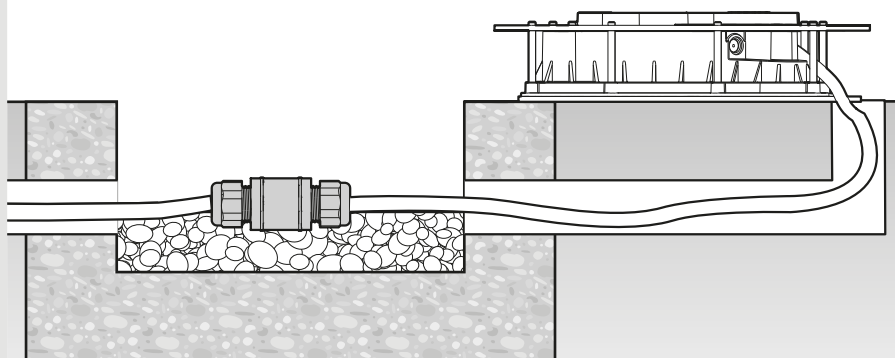

6

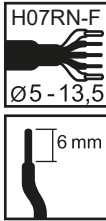
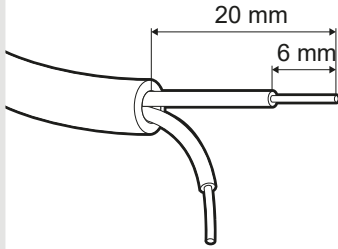

7

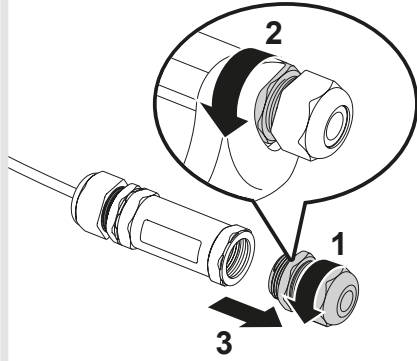

8

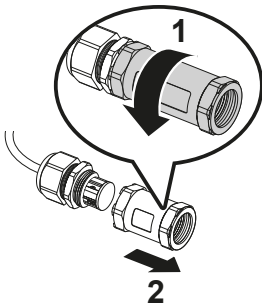

9

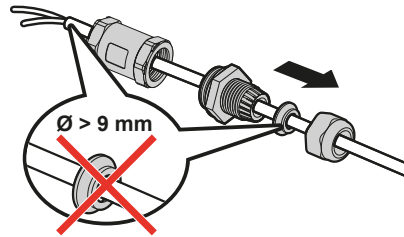

10

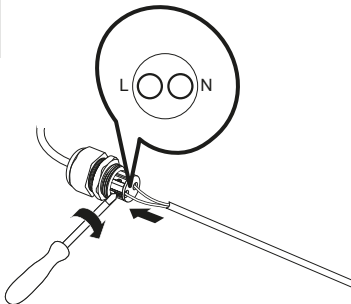

11

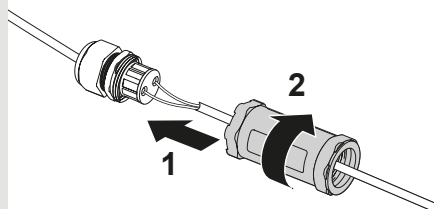

12

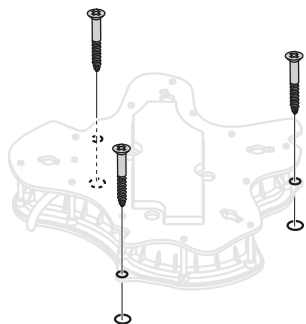

13

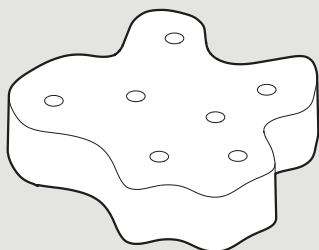
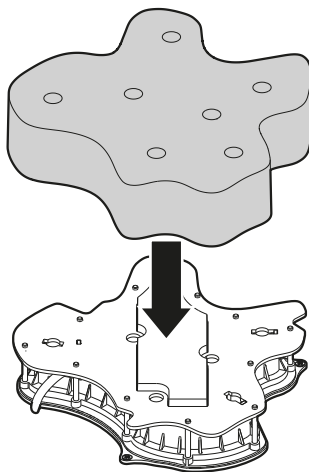

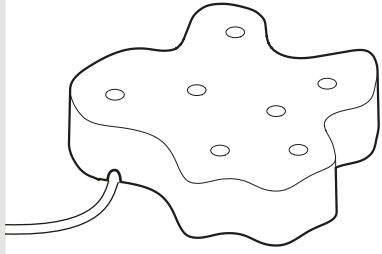

i



i

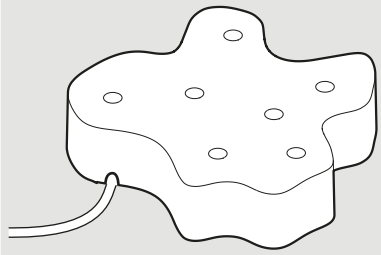
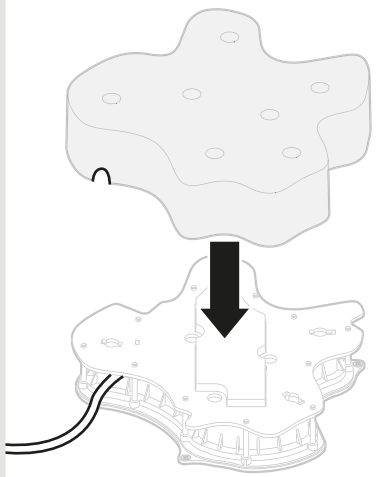

14

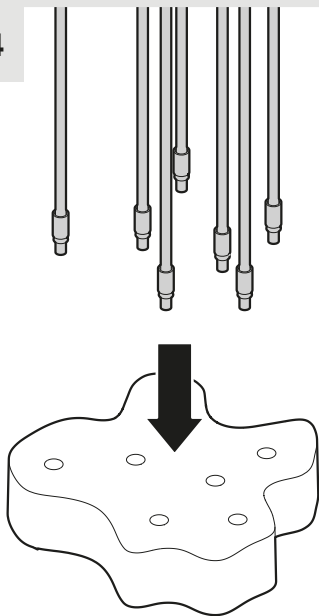

15

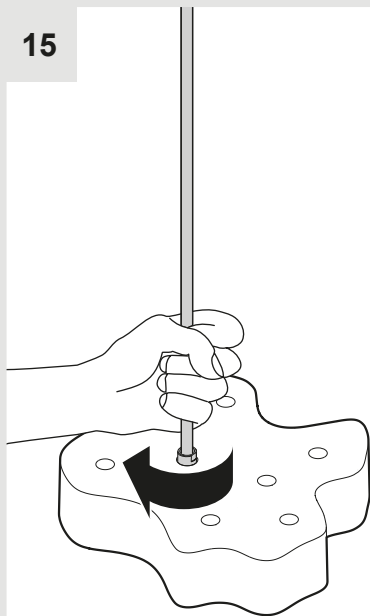

16

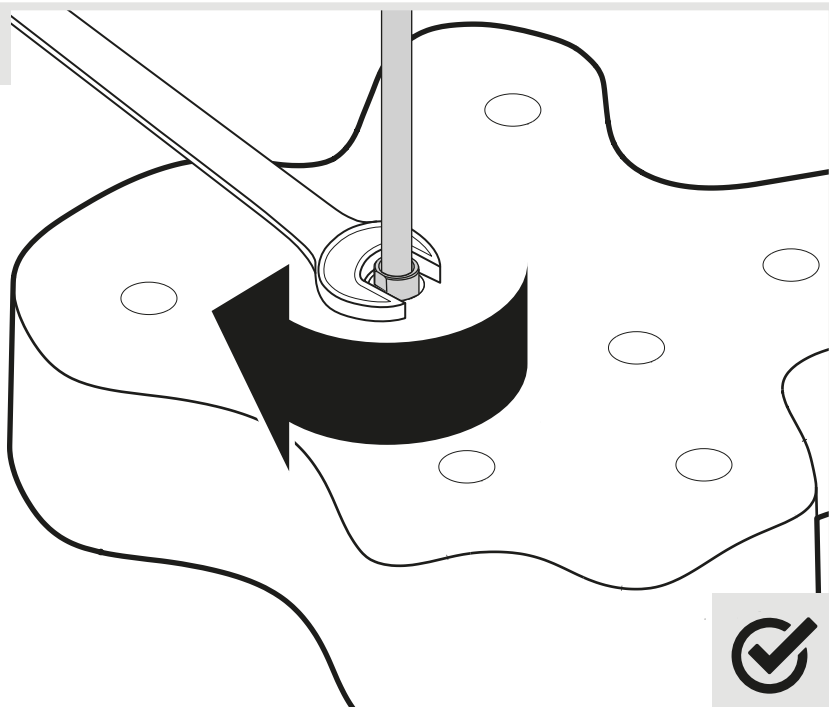

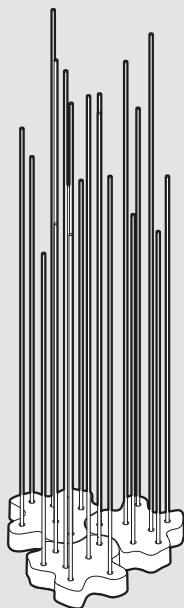
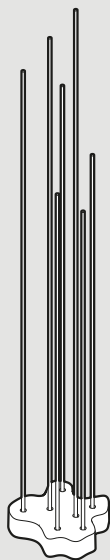

i

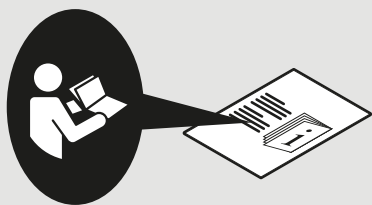

1

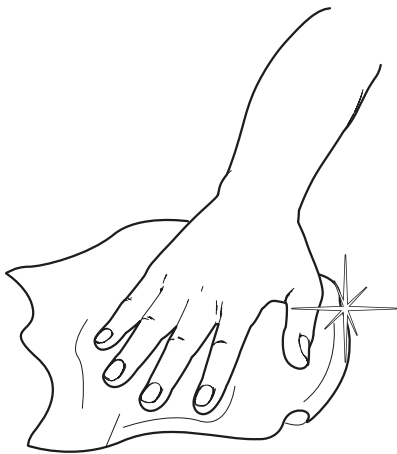

Artemide®

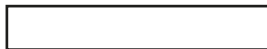

Artemide

via Bergamo, 18
20010 Pregnana M.se (MI)
ITALIA

tel. +39 02 935 181
fax +39 02 935 90 254
fax +39 02 935 90 496

www.artemide.com

VAT IT00846890150

cod. Y513000103D

Artemide®

PIASTRA D'UNIONE REEDS UL

design

Studio Artemide

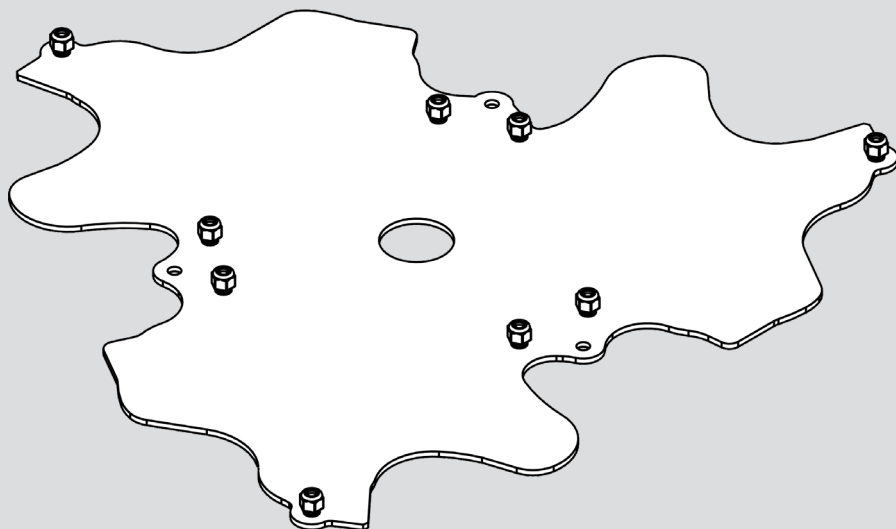



i

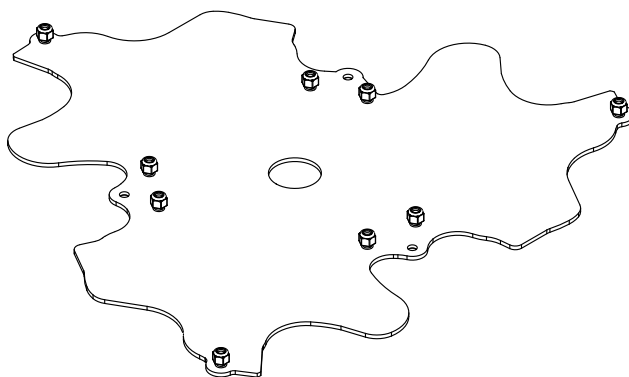
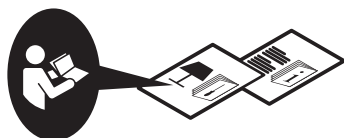

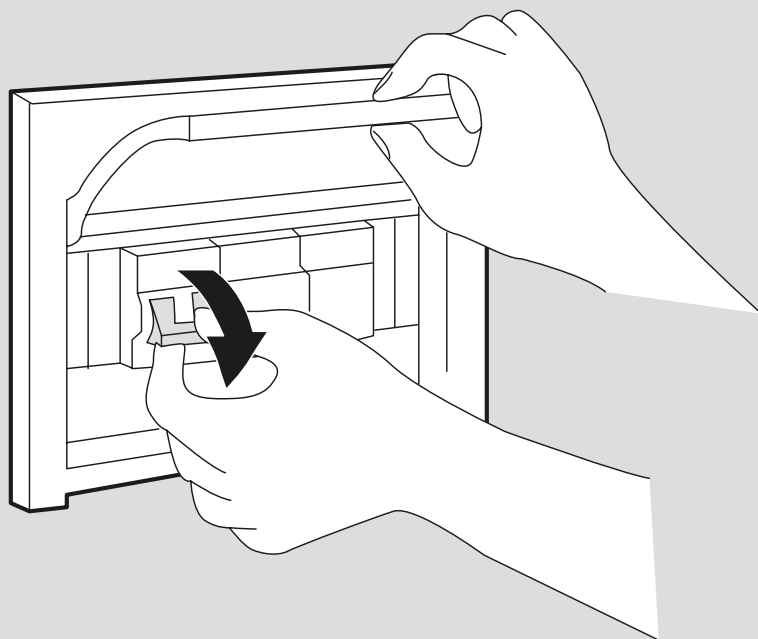

1

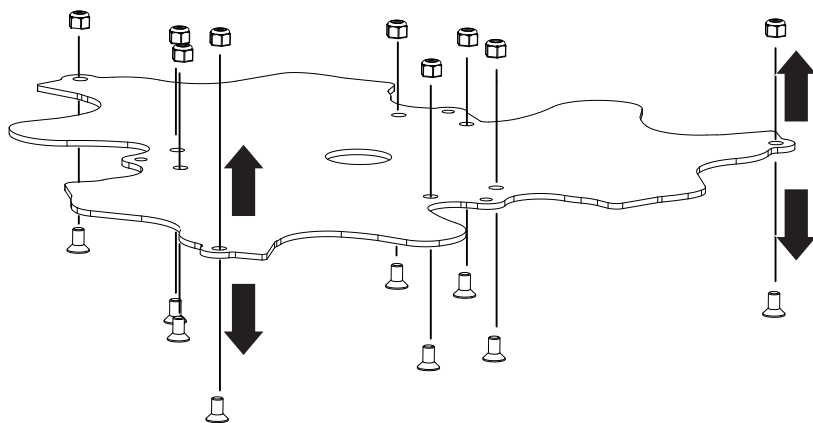

2



TS08750803

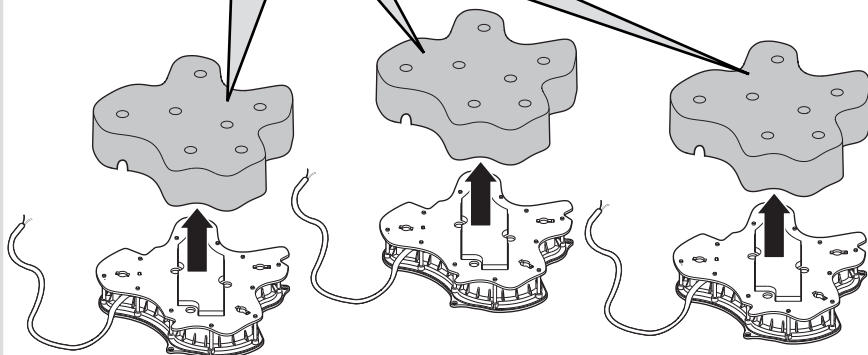

3

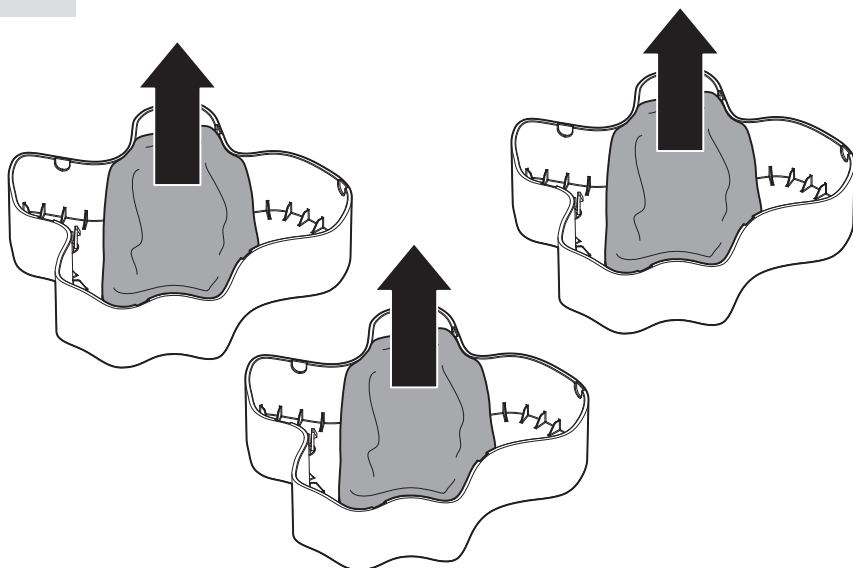

4

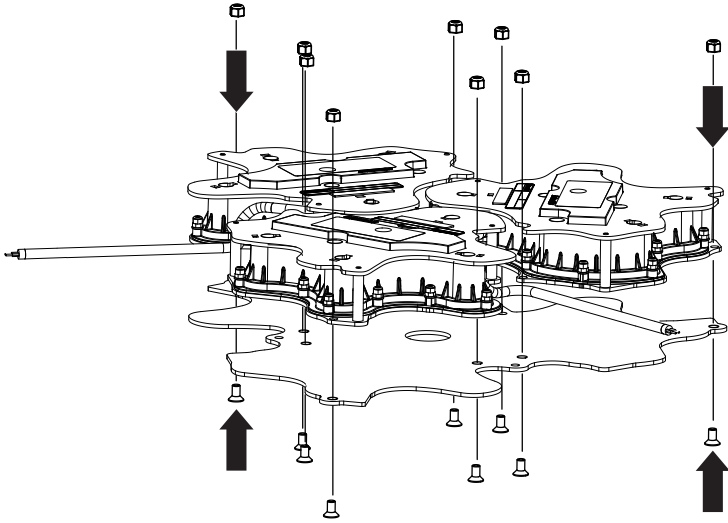

5

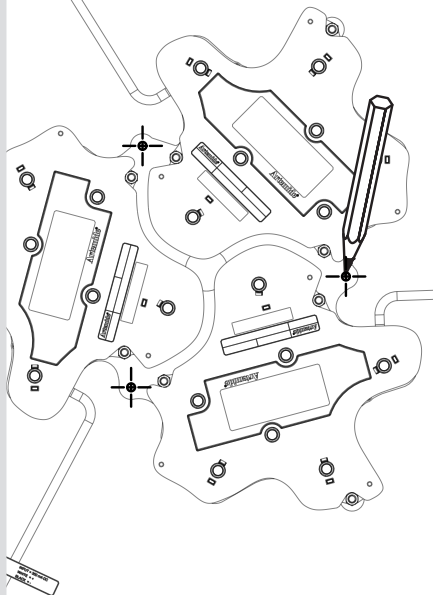

6

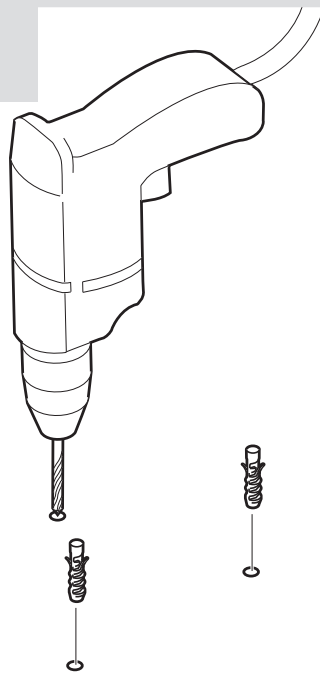

7a

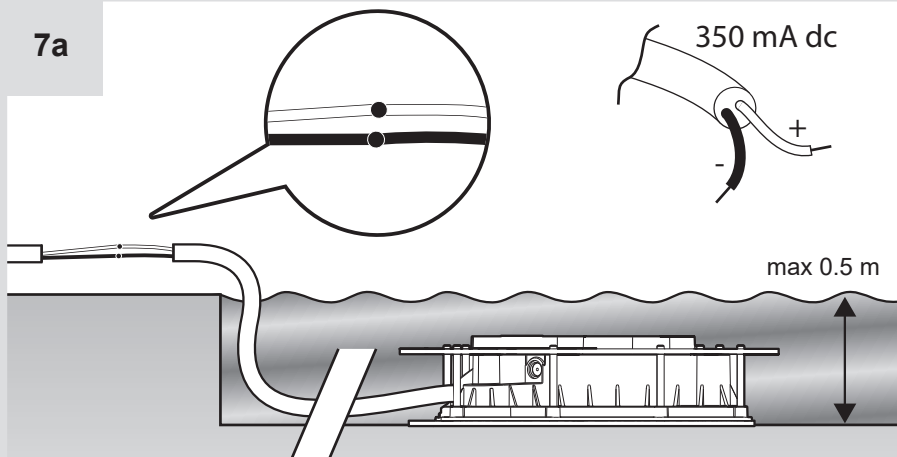

Ensure water-proof connection
Assurer une connexion étanche à l'eau
Asegurar la cennexión a prueba de aqua

+ white/blanc/blanco  white/blanc/blanco +
- black/noir/negro  black/noir/negro -

7b

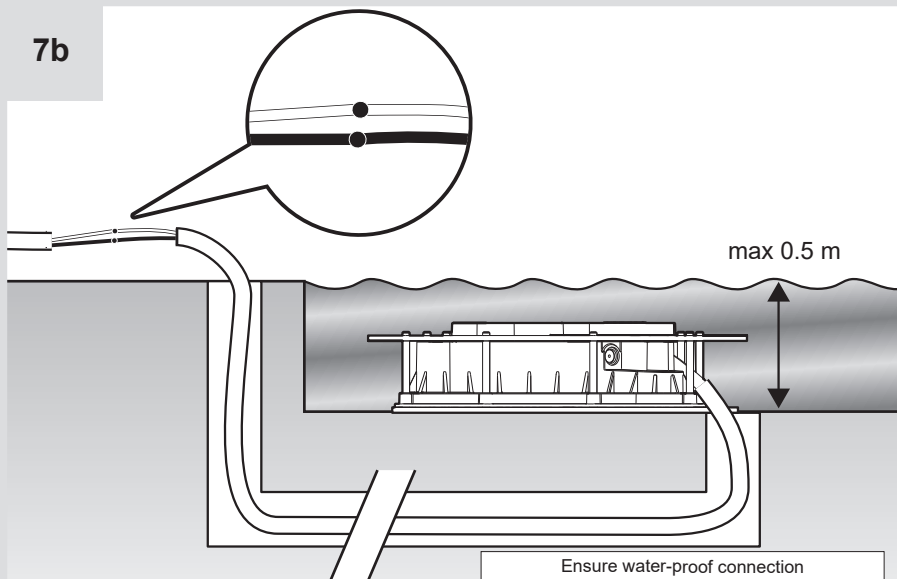

Ensure water-proof connection
Assurer une connexion étanche à l'eau
Asegurar la cennexión a prueba de aqua

+ white/blanc/blanco  white/blanc/blanco +
- black/noir/negro  black/noir/negro -

8

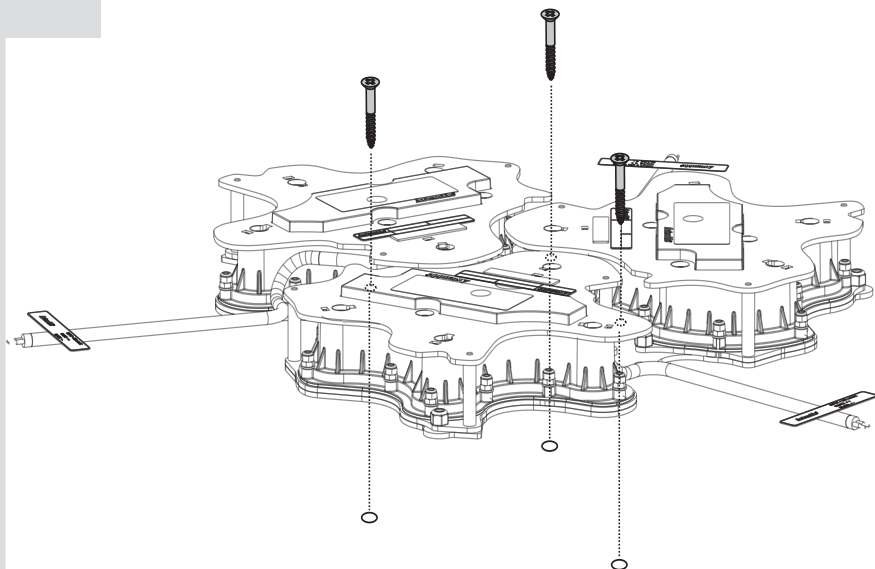

9

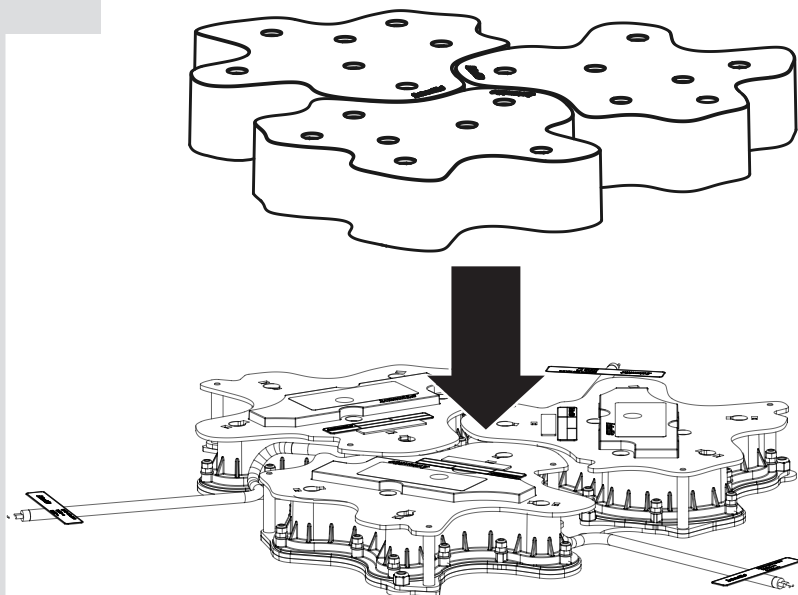

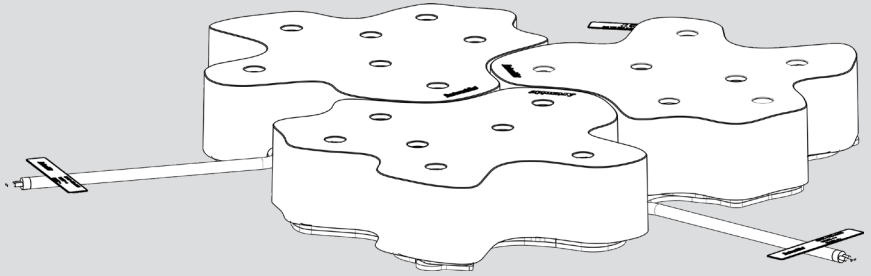

10

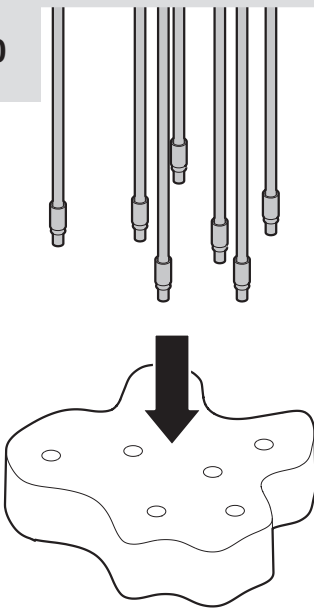

11

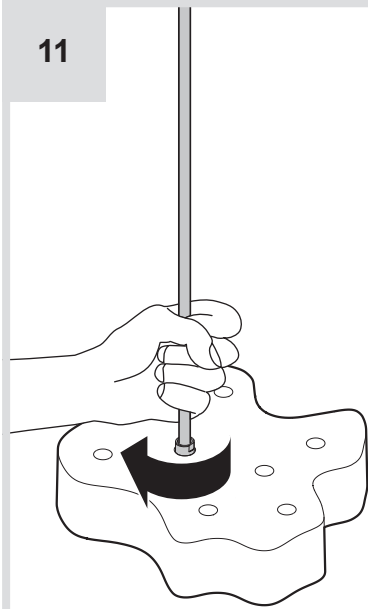

12

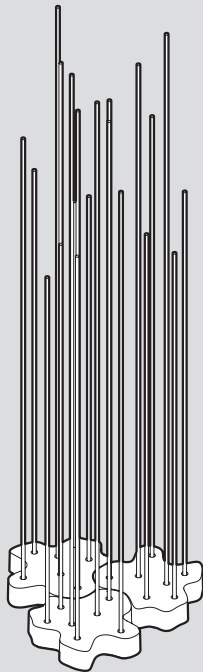
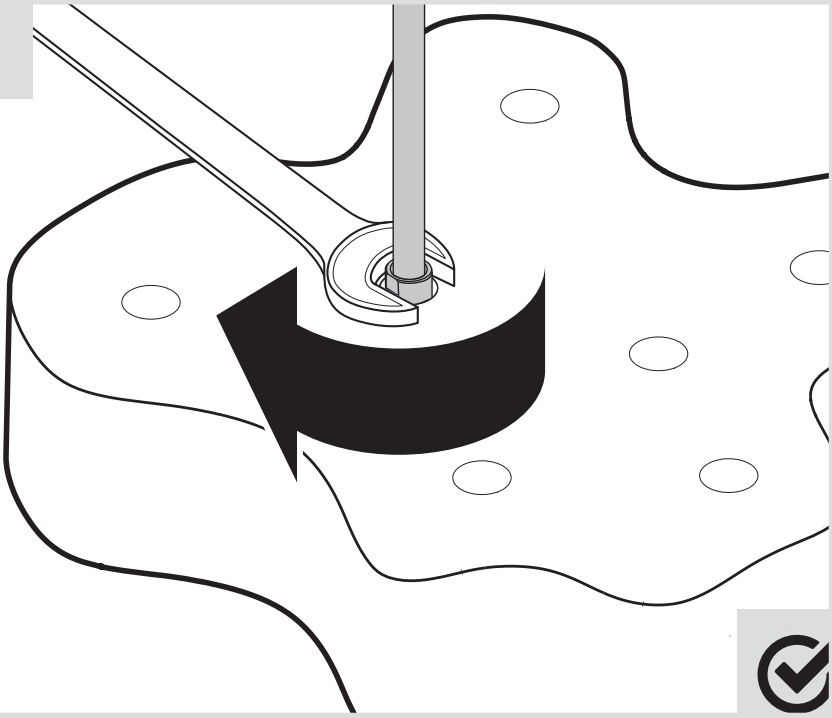

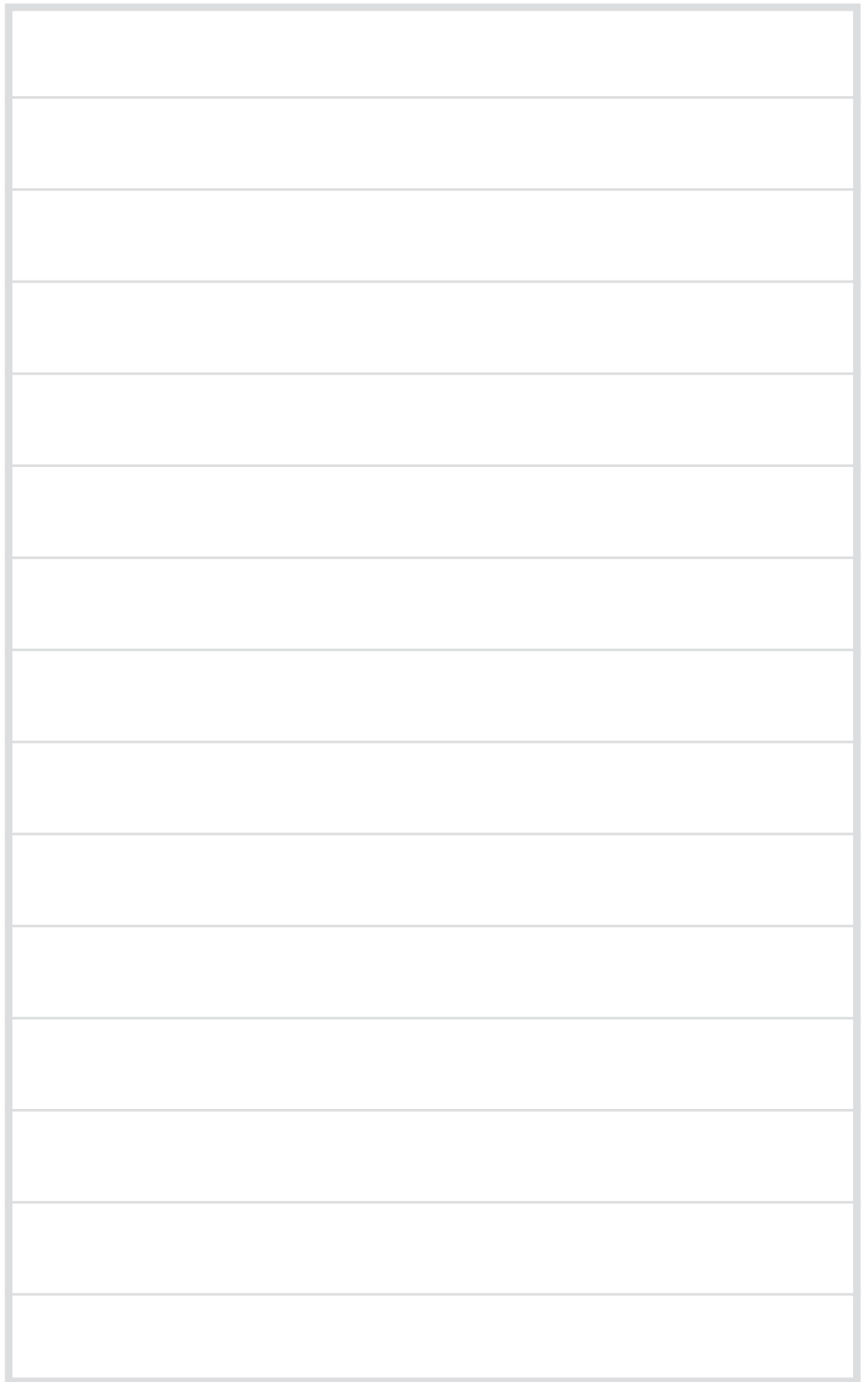

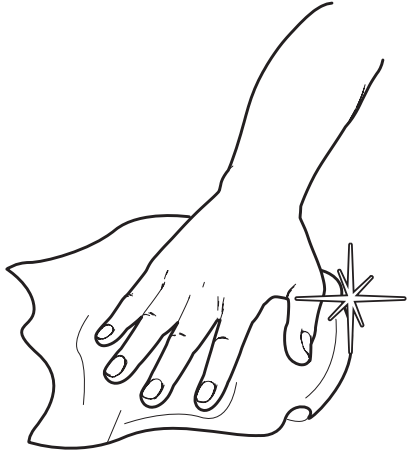
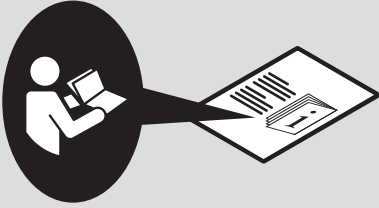

Artemide®



Artemide

via Bergamo, 18
20010 Pregnana M.se (MI)
ITALIA

tel. +39 02 935 181
fax +39 02 935 90 254
fax +39 02 935 90 496

www.artemide.com

VAT IT00846890150

Artemide Inc.

250 Karin Lane
Hicksville, NY 11801

Tel. 631 694 9292
Toll Free 1-877-Art-9111
Fax 631 694 9275

www.artemide.net

Artemide Ltée/Ltd.

11105 rue Renaude Lapointe
Montréal, Québec H1J 2T4

Tel. 514 323 6537
Toll Free 888 777 2783
Fax 514 323 8864

www.artemide.net

cod. Y513001773