

## MODULO SINGLE WALL

Designed by Federico Peri for CTO Lighting, MODULO is a collection of chandelier, pendant and wall lights distinguished by its modular form, arranged in linear configurations, creating versatile lighting sculptures.

### FINISH

satin brass with smoked kiln cast glass and matt opal glass shades  
MODWA1BSKMO

bronze with smoked kiln cast glass and matt opal glass shades  
MODWA1BZSKMO

### BULBS

integrated LED - trailing edge dimmable - 4.5w - 2700k

### DESIGNER

Federico Peri

### WEIGHT

1kg (2.2lbs)

### CERTIFICATION

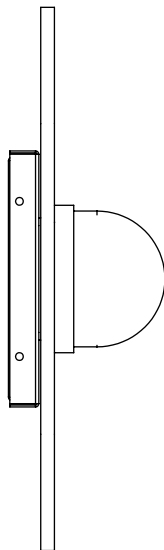
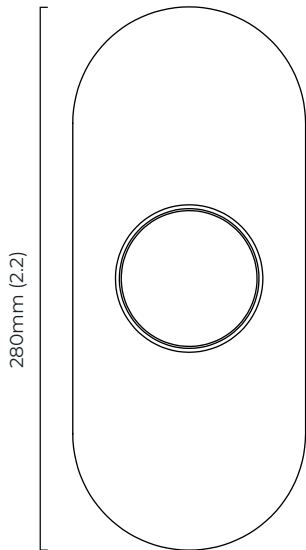

Mounting plate dimensions

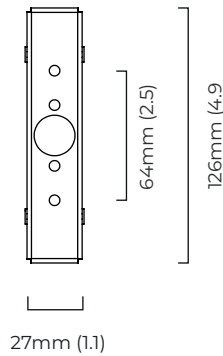

North America junction box cover

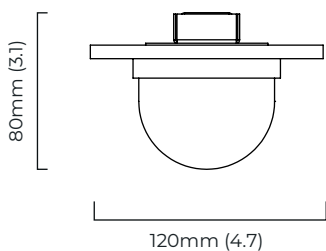
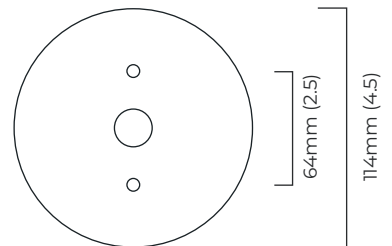

|                           | Input Voltage | As Standard | On Request |
|---------------------------|---------------|-------------|------------|
| Phase Cut (rotary dimmer) | 230           | ✓           |            |
| 0/1-10V230                | 230           | ✗           | ✗          |
| DALi                      | 230           | ✗           | ✓          |
| Phase Cut (rotary dimmer) | 120           | ✓           |            |
| 0/1-10V120                | 120           | ✗           | ✗          |
| DALi                      | 120           | ✗           | ✗          |

## MODULO TWIN WALL

Designed by Federico Peri for CTO Lighting, MODULO is a collection of chandelier, pendant and wall lights distinguished by its modular form, arranged in linear configurations, creating versatile lighting sculptures.

### FINISH

satin brass with smoked kiln cast glass and matt opal glass shades  
MODWA2SBSKMO

bronze with smoked kiln cast glass and matt opal glass shades  
MODWA2BZSKMO

### BULBS

integrated LED - trailing edge dimmable - 9w - 2700k

### DESIGNER

Federico Peri

### WEIGHT

2kg (4.4lbs)

### CERTIFICATION

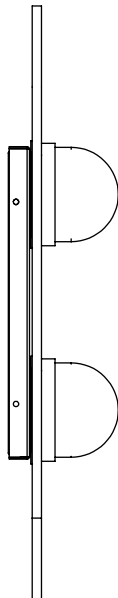
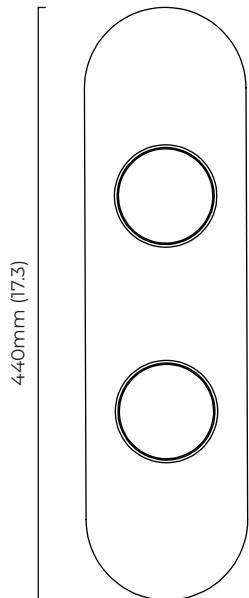

Mounting plate dimensions

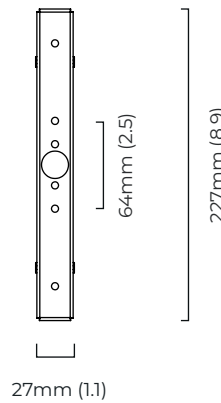

North America junction box cover

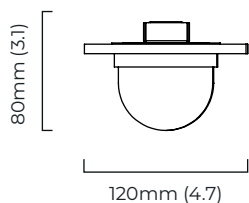
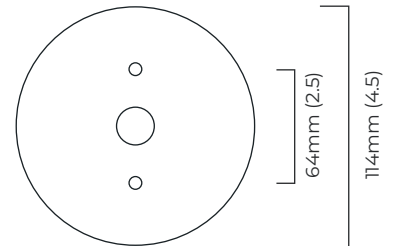

|                           | Input Voltage | As Standard | On Request |
|---------------------------|---------------|-------------|------------|
| Phase Cut (rotary dimmer) | 230           | ✓           |            |
| 0/1-10V230                | 230           | ✗           | ✗          |
| DALi                      | 230           | ✗           | ✓          |
| Phase Cut (rotary dimmer) | 120           | ✓           |            |
| 0/1-10V120                | 120           | ✗           | ✗          |
| DALi                      | 120           | ✗           | ✗          |

## MODULO TRIPLE WALL

Designed by Federico Peri for CTO Lighting, MODULO is a collection of chandelier, pendant and wall lights distinguished by its modular form, arranged in linear configurations, creating versatile lighting sculptures.

### FINISH

satin brass with smoked kiln cast glass and matt opal glass shades  
MODWA3SBSKMO

bronze with smoked kiln cast glass and matt opal glass shades  
MODWA3BZSKMO

### BULBS

integrated LED - trailing edge dimmable - 13.5w - 2700k

### DESIGNER

Federico Peri

### WEIGHT

3kg (6.6lbs)

### CERTIFICATION

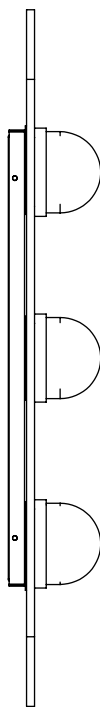
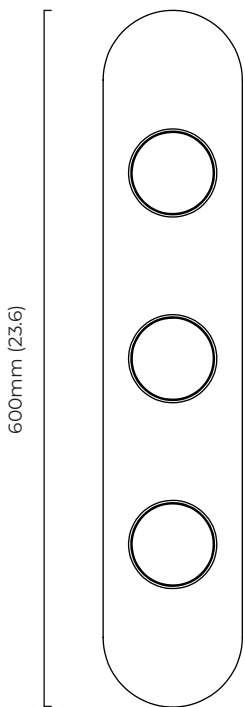

Mounting plate dimensions

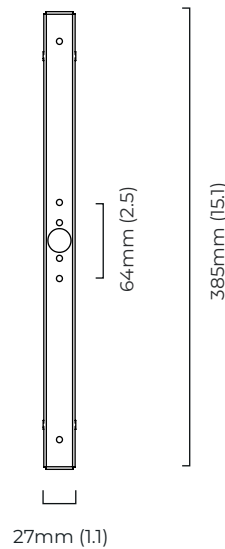

North America junction box cover

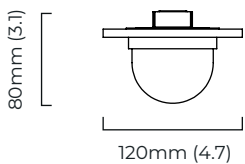
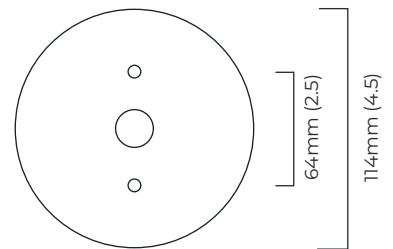

|                           | Input Voltage | As Standard | On Request |
|---------------------------|---------------|-------------|------------|
| Phase Cut (rotary dimmer) | 230           | ✓           |            |
| 0/1-10V230                | 230           | ✗           | ✗          |
| DALi                      | 230           | ✗           | ✓          |
| Phase Cut (rotary dimmer) | 120           | ✓           |            |
| 0/1-10V120                | 120           | ✗           | ✗          |
| DALi                      | 120           | ✗           | ✗          |