

Artemide®

Meteorite 15

design
Pio & Tito Toso

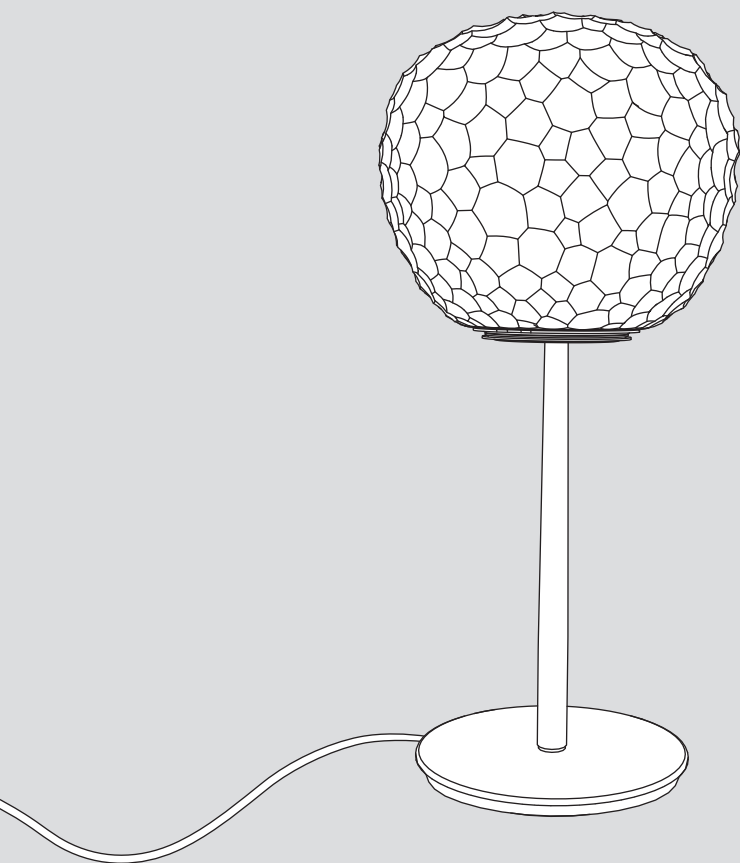



i

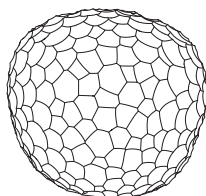
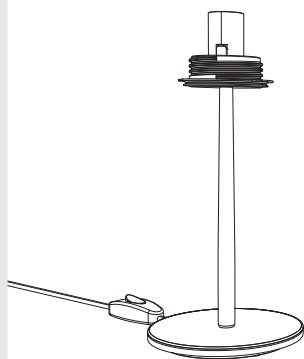
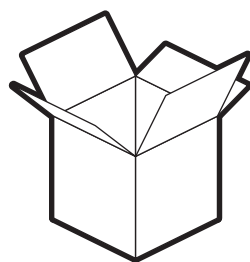
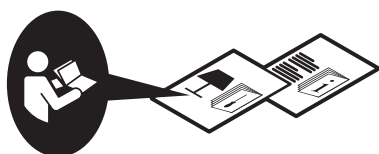
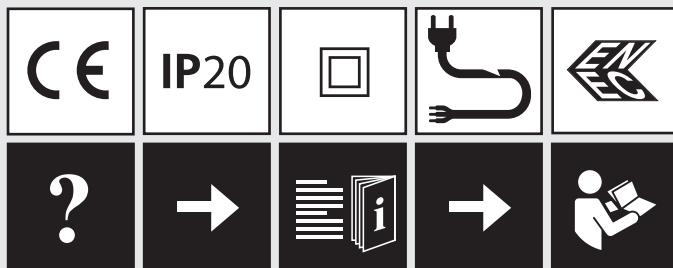

1

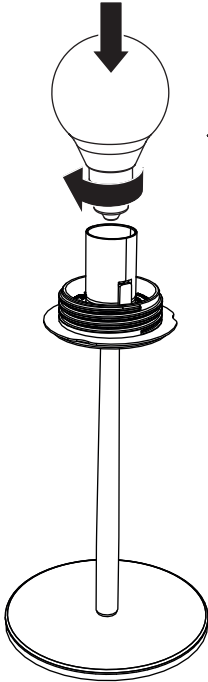

Max 4W LED E14

For USA and Canada only:
Max 4W E12 cULus SBLED

2

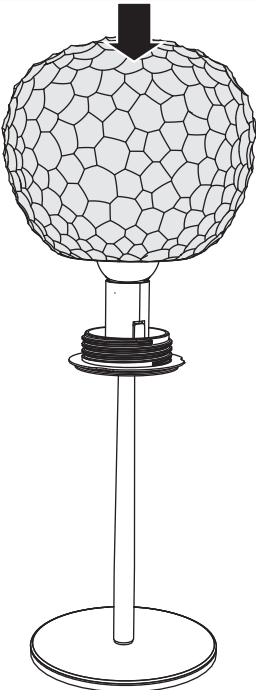

3

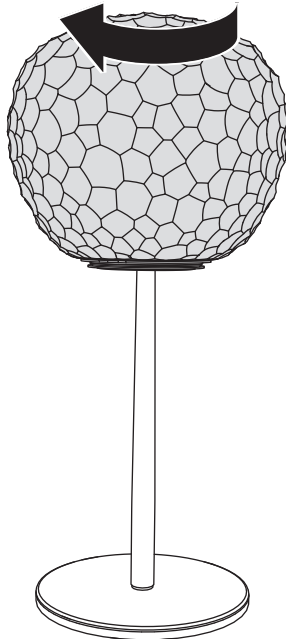



4

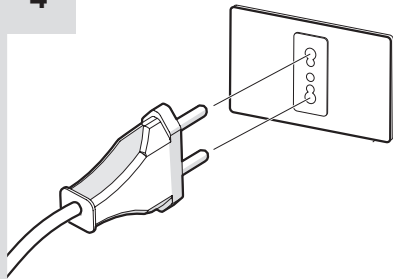

For USA and Canada only

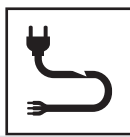
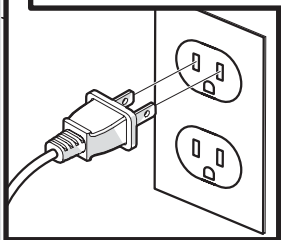

5

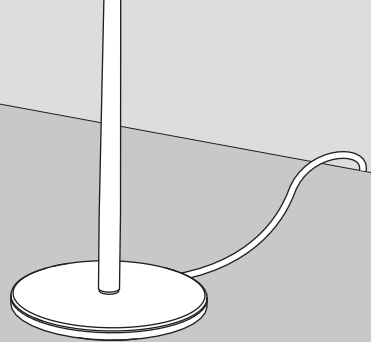
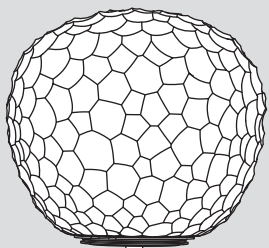
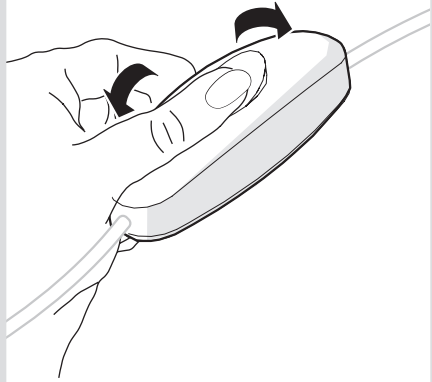
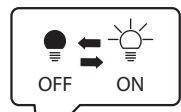



i

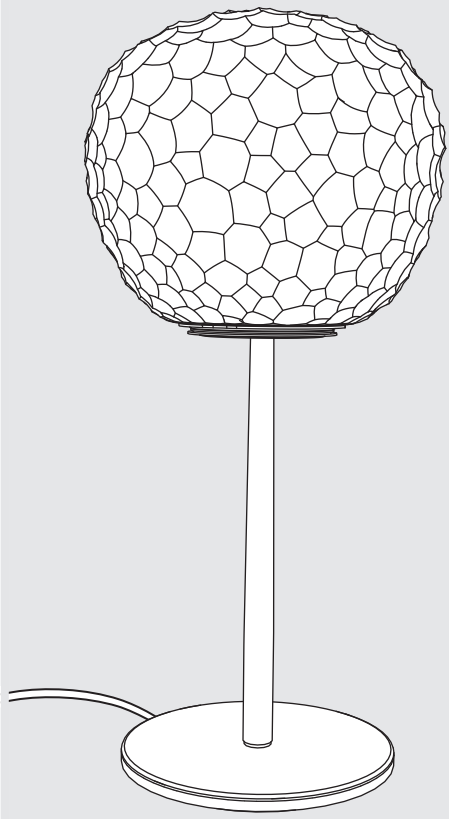
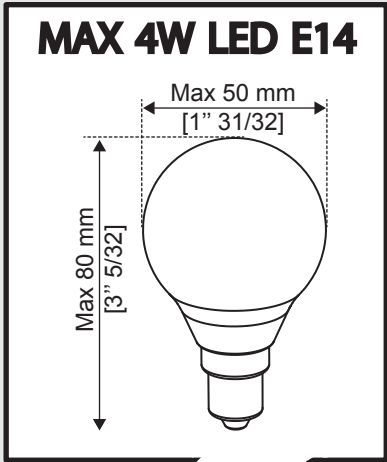

For USA and Canada only:
Max 4W E12 cULus SBLED

1

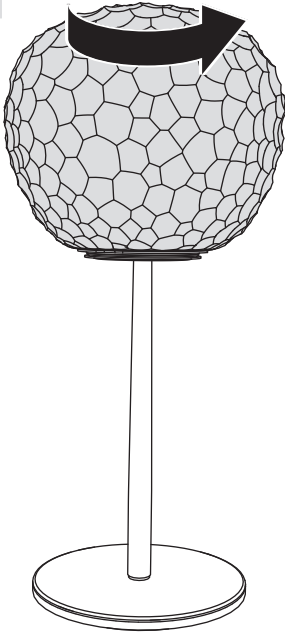

2

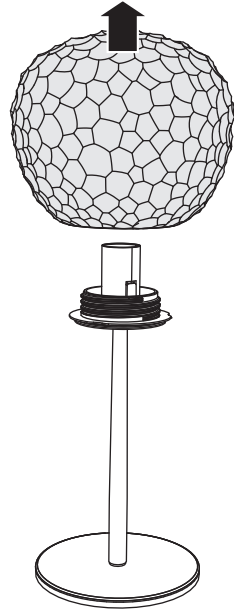

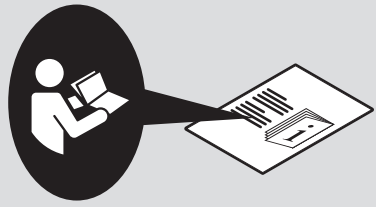

Artemide®



Artemide

via Bergamo, 18
20010 Pregnana M.se (MI)
ITALIA

tel. +39 02 935 181
fax +39 02 935 90 254
fax +39 02 935 90 496

www.artemide.com

VAT IT00846890150

Artemide Inc.

250 Karin Lane
Hicksville, NY 11801

Tel. 631 694 9292
Toll Free 1-877-Art-9111
Fax 631 694 9275

www.artemide.net

Artemide Ltée/Ltd.

11105 rue Renaude Lapointe
Montréal, Québec H1J 2T4

Tel. 514 323 6537
Toll Free 888 777 2783
Fax 514 323 8864

www.artemide.net

cod. Y513000997

Artemide®

Meteorite 35

design
Pio & Tito Toso

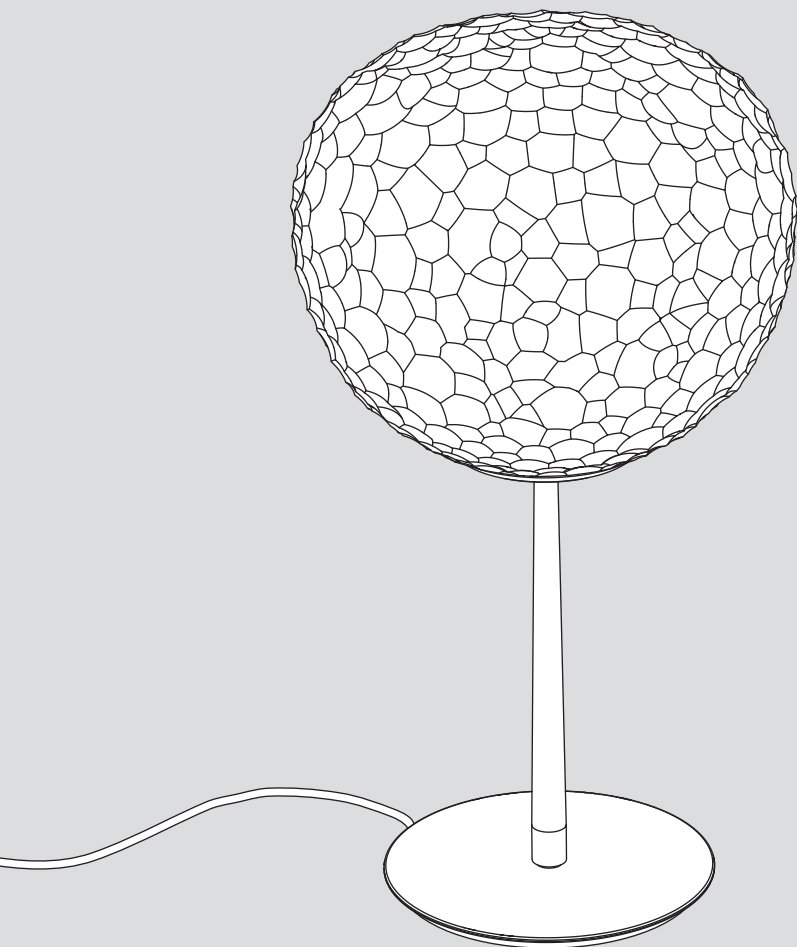



i

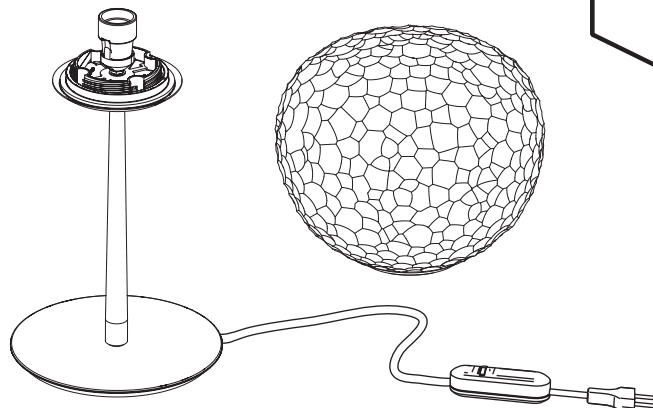
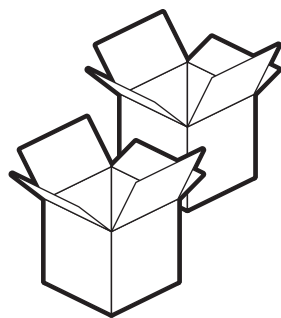
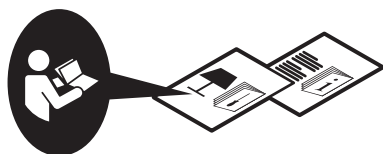
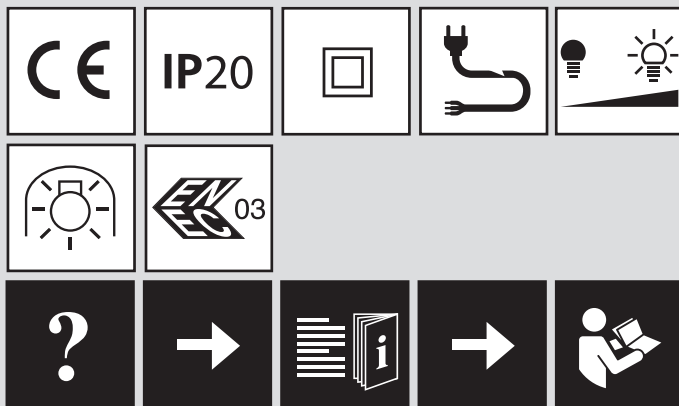

1

E27 - MAX 150W

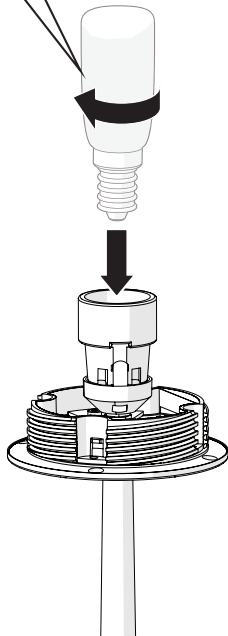

2

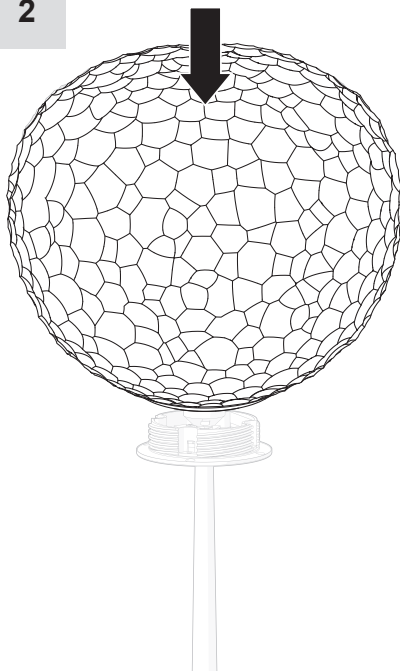

3

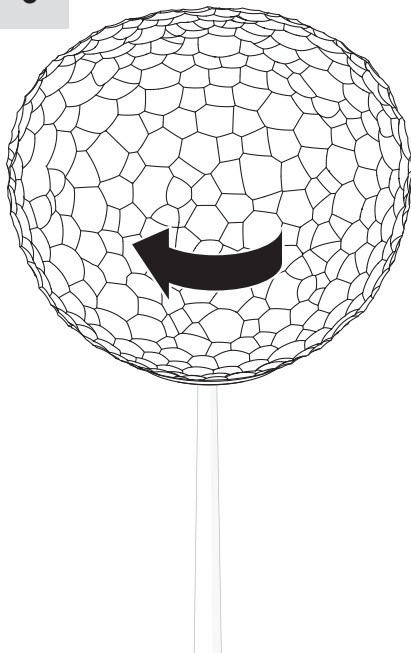

4

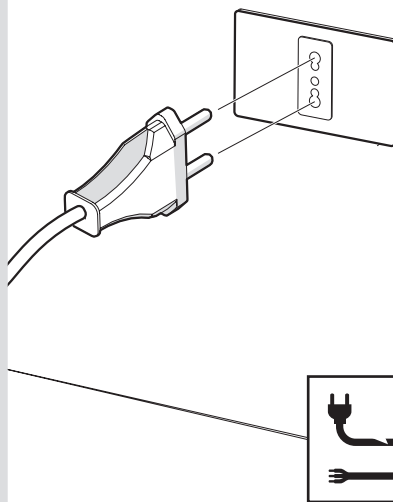

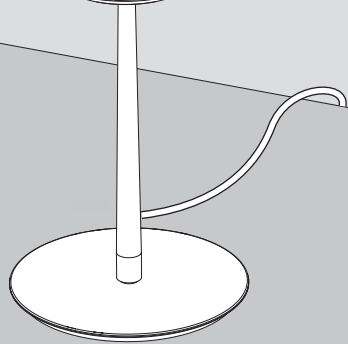
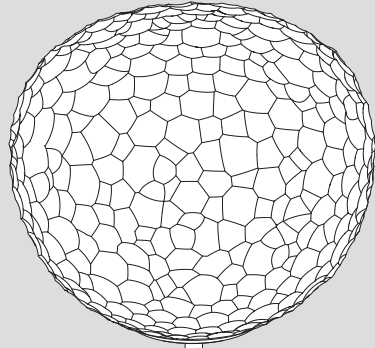



5a

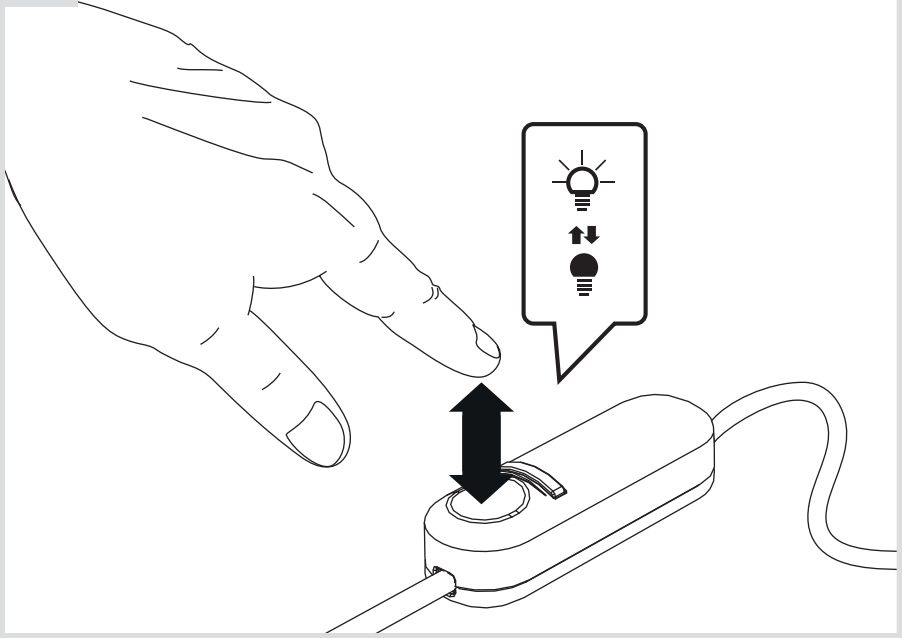

5b

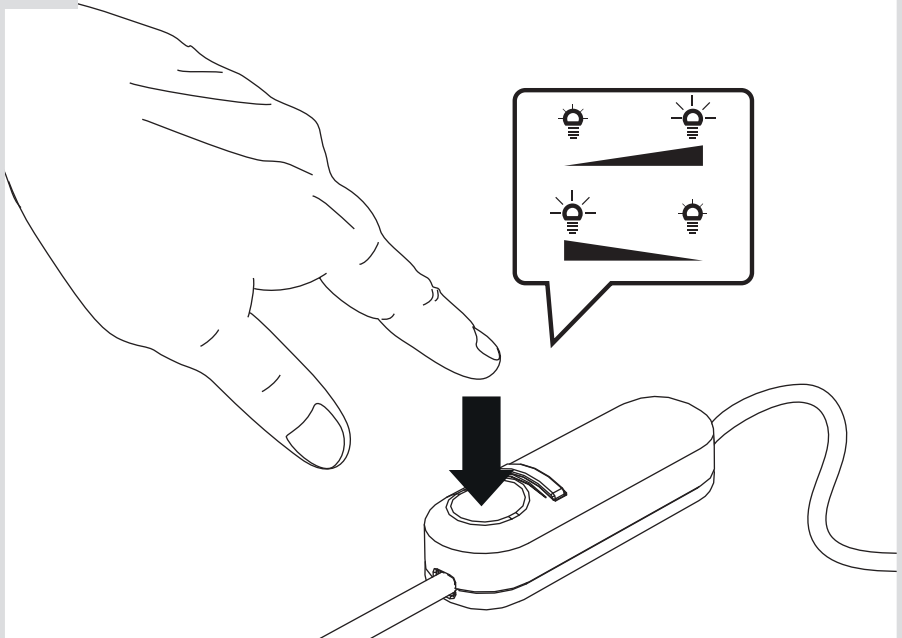



i

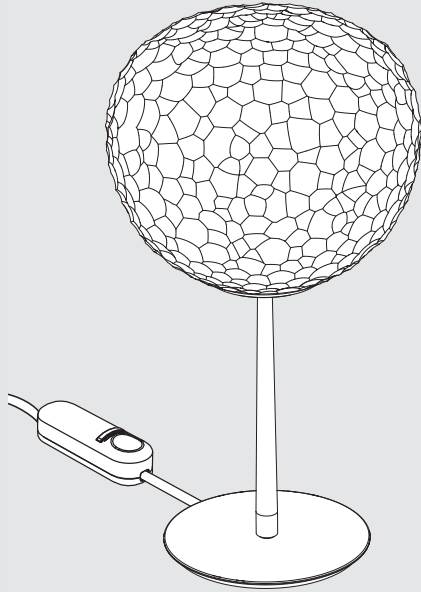

MAX 150W - E27

Halo: HSGST - 2900 lm

LED: DRAA - 2500 lm

1

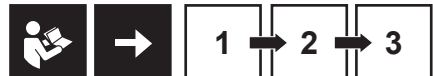
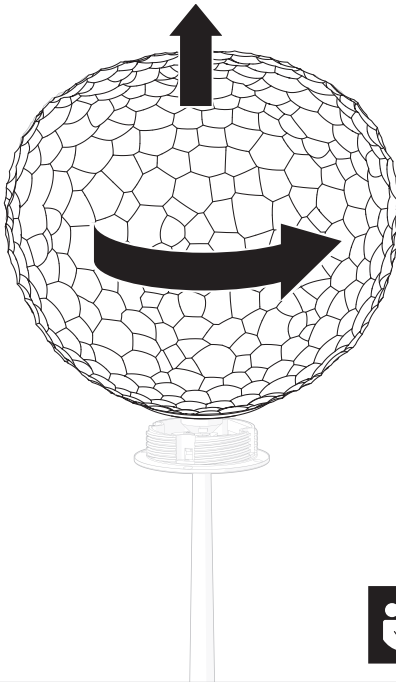

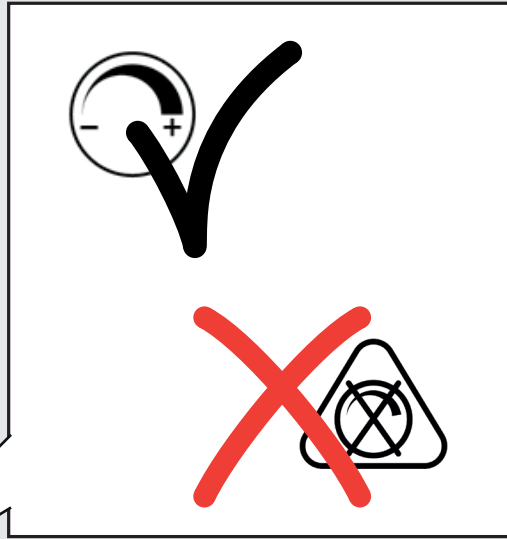
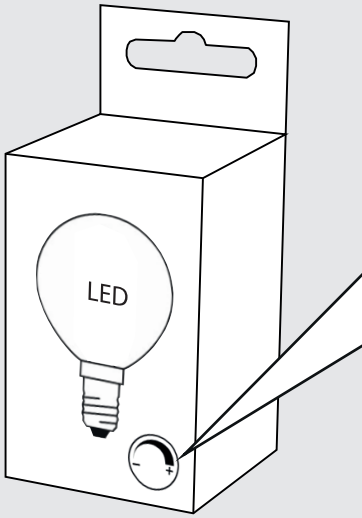

Artemide®



Artemide

via Bergamo, 18
20010 Pregnana M.se (MI)
ITALIA

tel. +39 02 935 181
fax +39 02 935 90 254
fax +39 02 935 90 496

www.artemide.com

VAT IT00846890150

cod. Y513000572