

Artemide®

Meteorite 15

design
Pio & Tito Toso

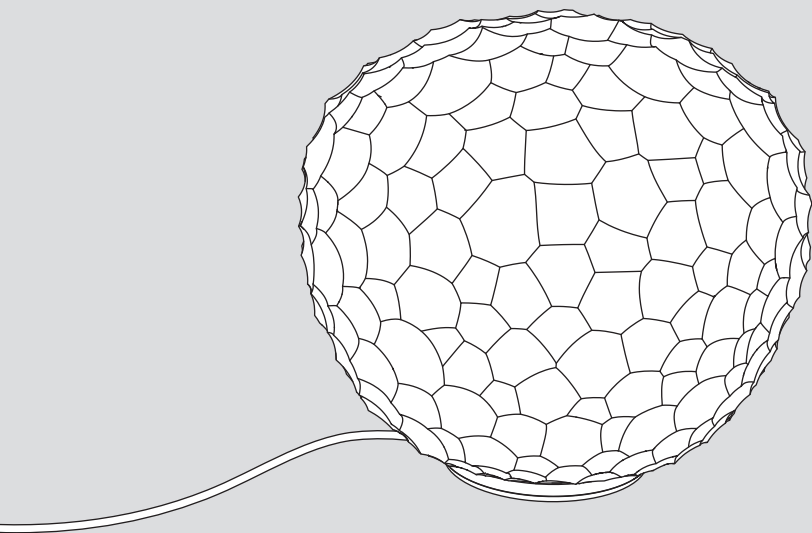



i

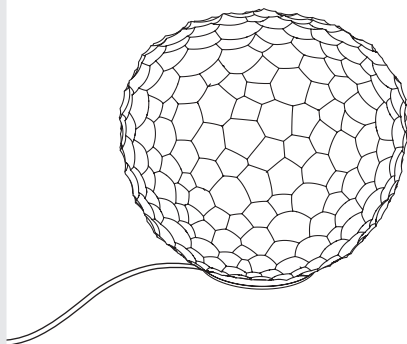
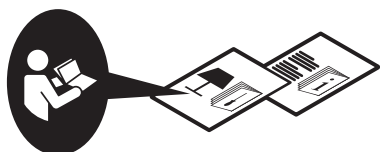
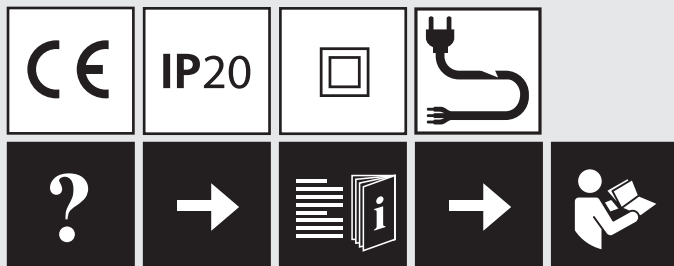

1

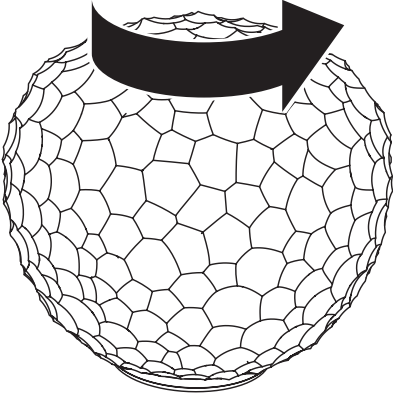

2

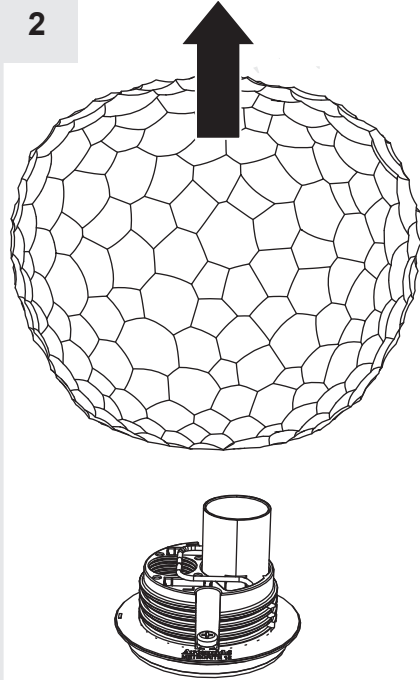

3

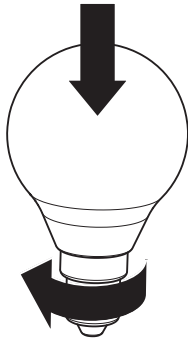

Max 4W LED E14

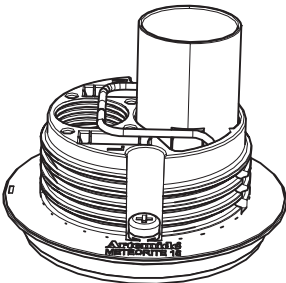

For USA and Canada only:
Max 4W E12 cULus SBLED

4

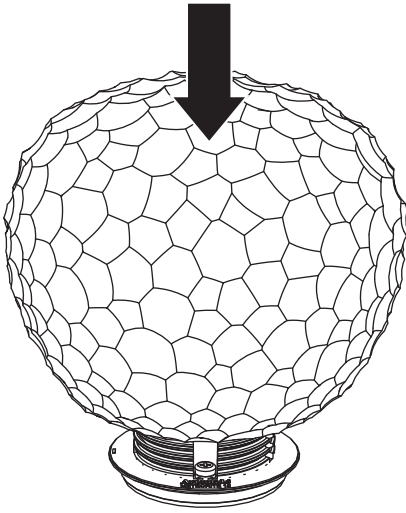

5

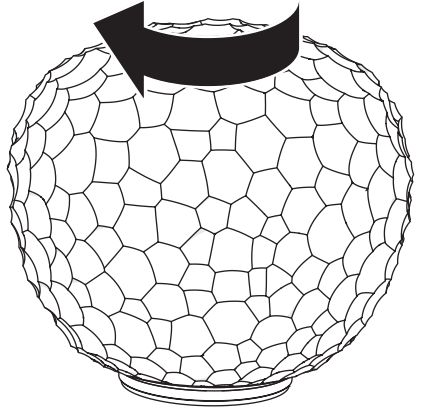

6

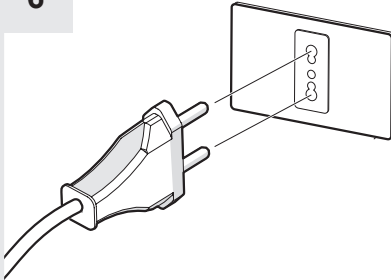

For USA and Canada only

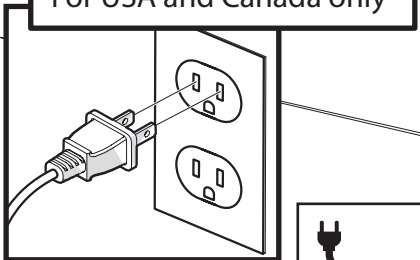

7

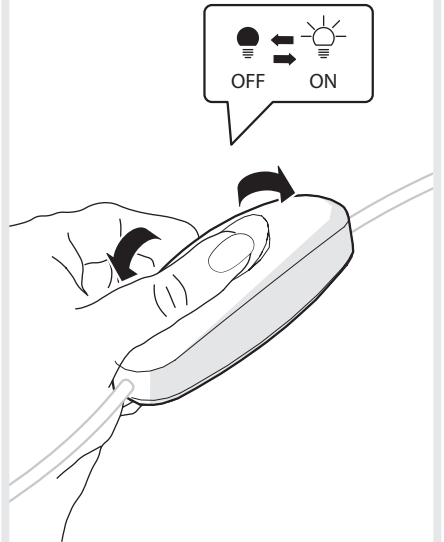

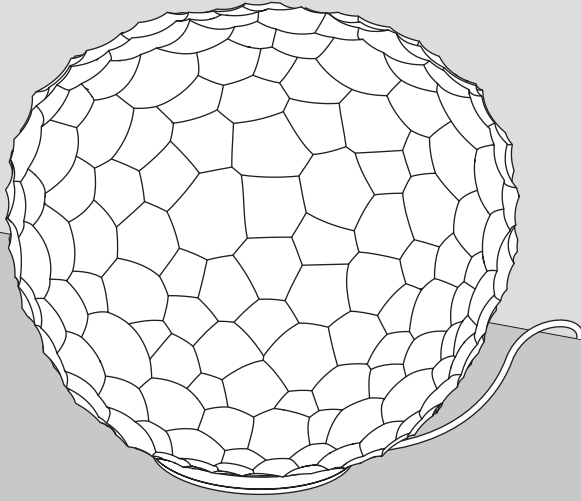



i



- 1
- 2
- 3
- 4
- 5

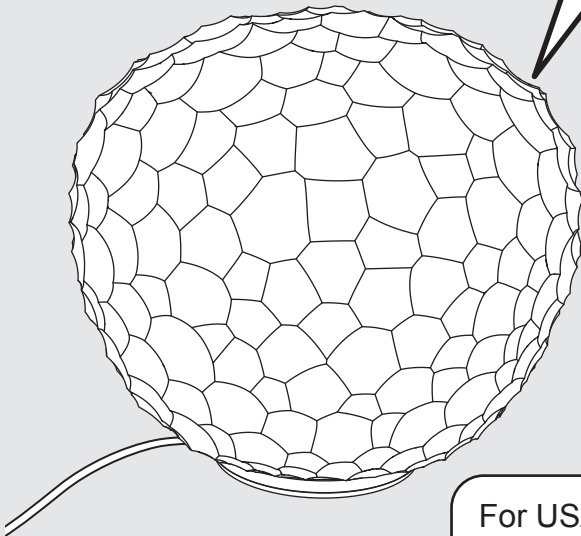
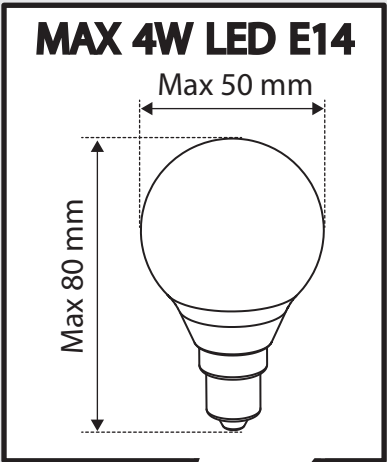

For USA and Canada only:
Max 4W E12 cULus SBLED



Artemide®



Artemide

via Bergamo, 18
20010 Pregnana M.se (MI)
ITALIA

tel. +39 02 935 181
fax +39 02 935 90 254
fax +39 02 935 90 496

www.artemide.com

VAT IT00846890150

Artemide Inc.

250 Karin Lane
Hicksville, NY 11801

Tel. 631 694 9292
Toll Free 1-877-Art-9111
Fax 631 694 9275

www.artemide.net

Artemide Ltée/Ltd.

11105 rue Renaude Lapointe
Montréal, Québec H1J 2T4

Tel. 514 323 6537
Toll Free 888 777 2783
Fax 514 323 8864

www.artemide.net

cod. Y513000929

Artemide®

Meteorite

design
Pio & Tito Toso

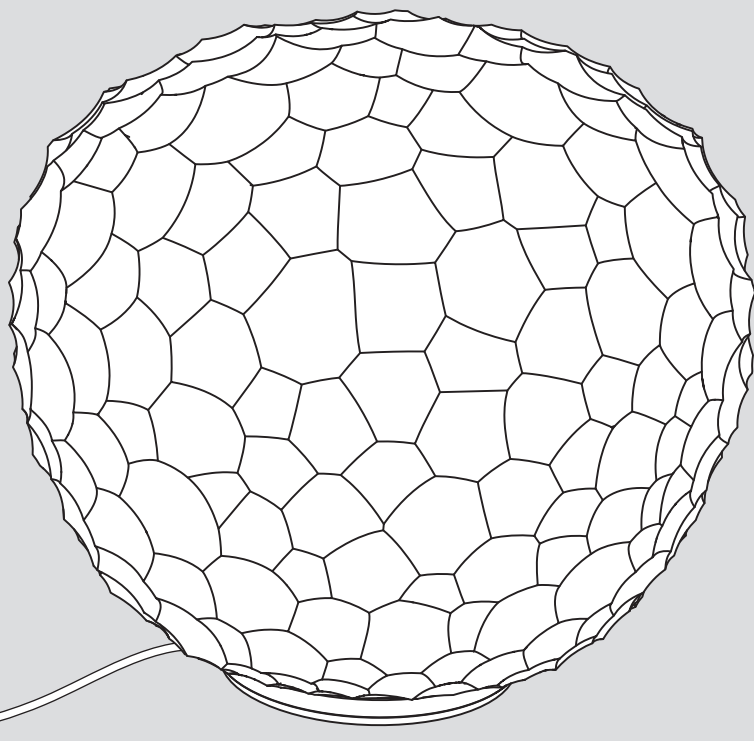



i

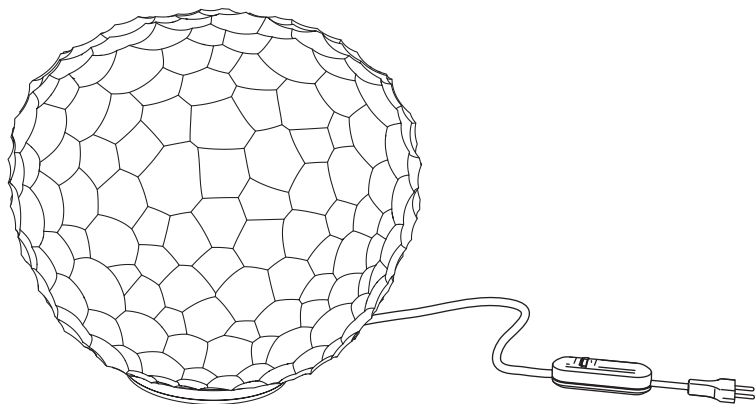
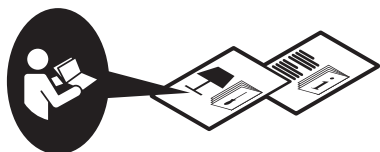
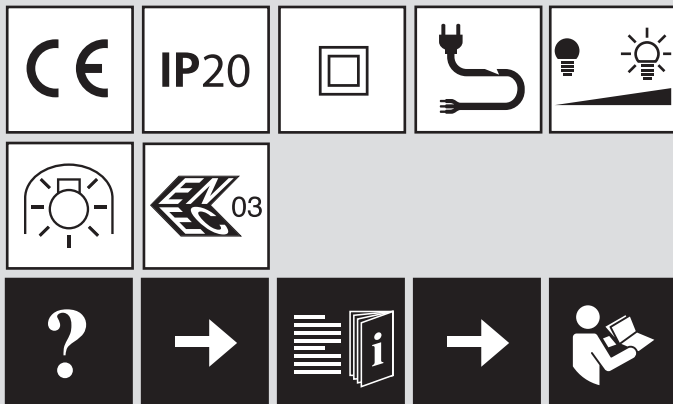

1

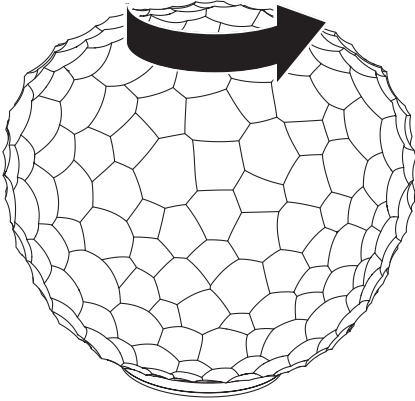

2

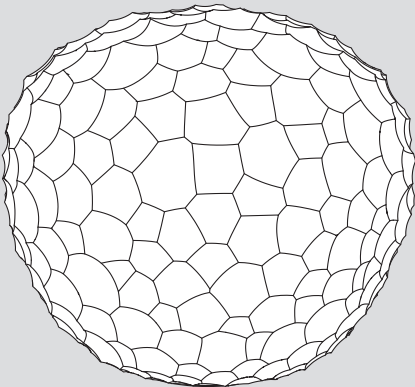
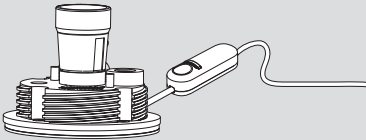
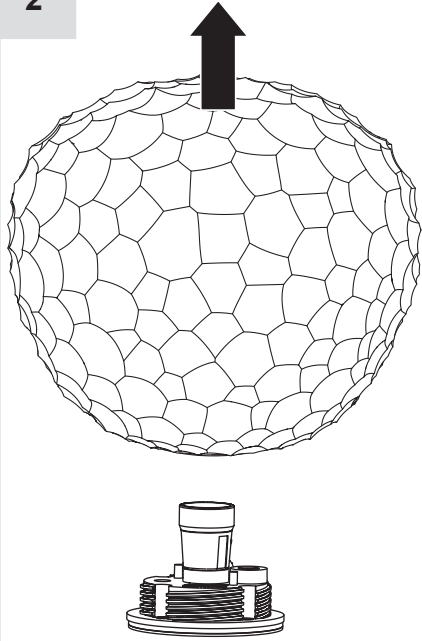

3

E27 - MAX 150W

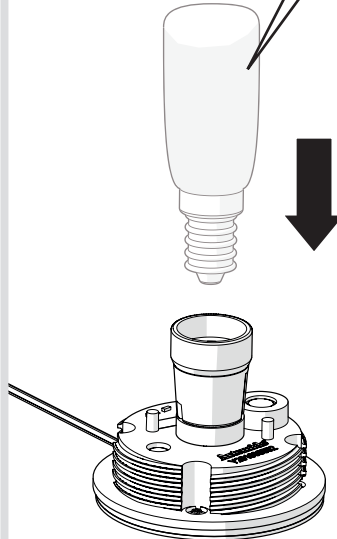

4

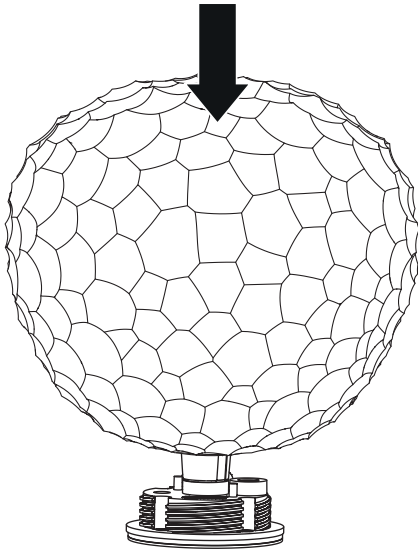

5

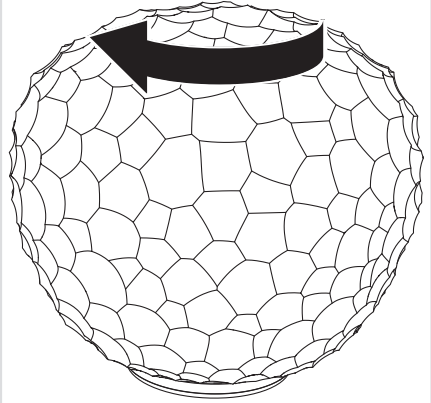

6

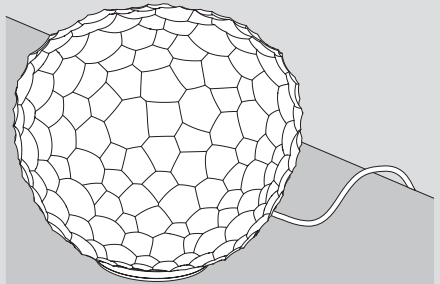
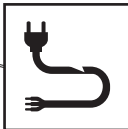
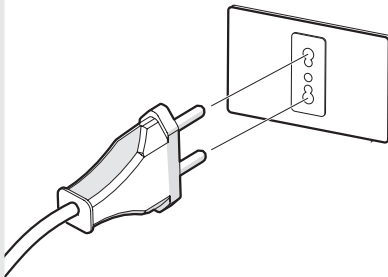



7a

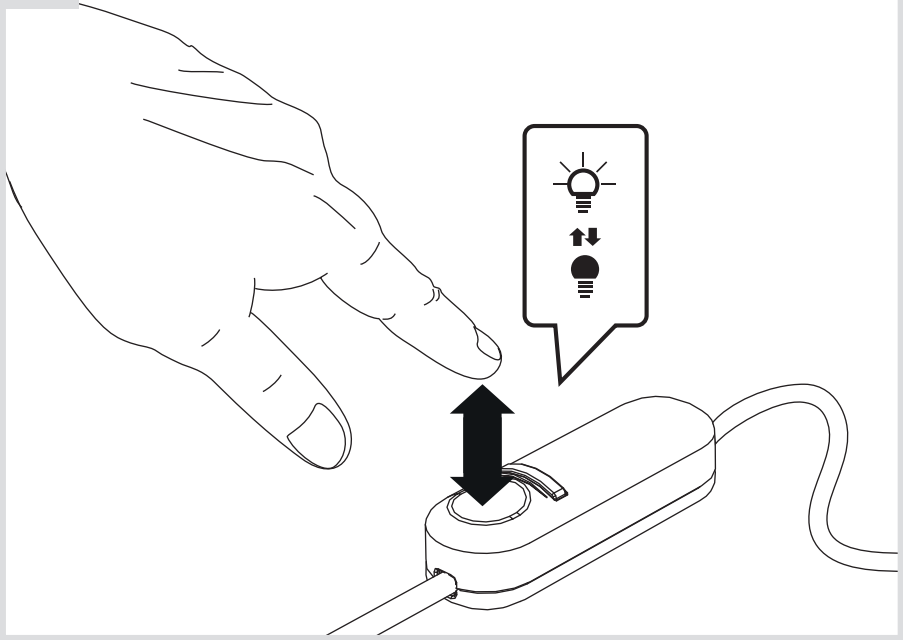

7b

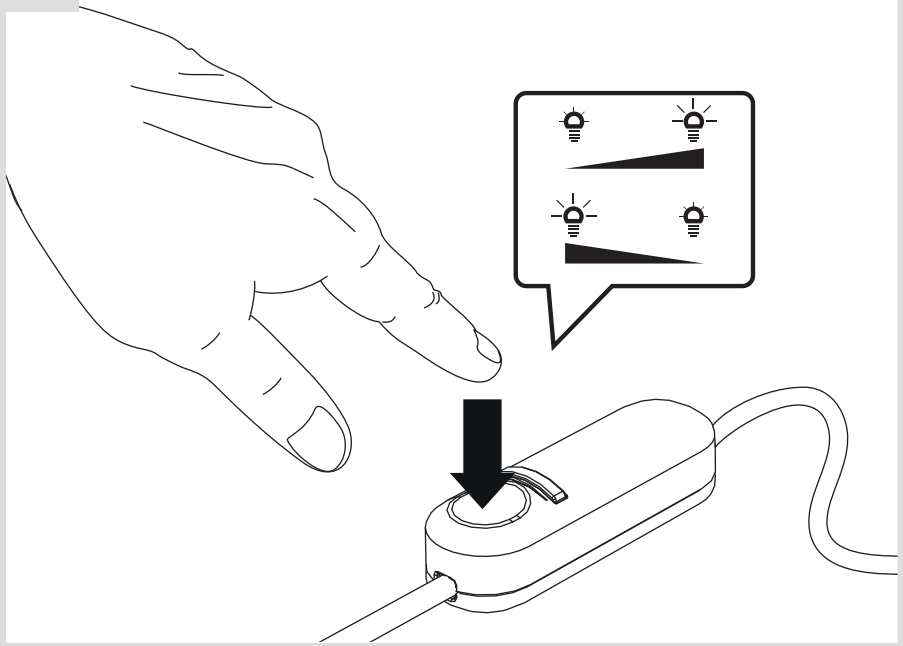



i



1

2

3

4

5

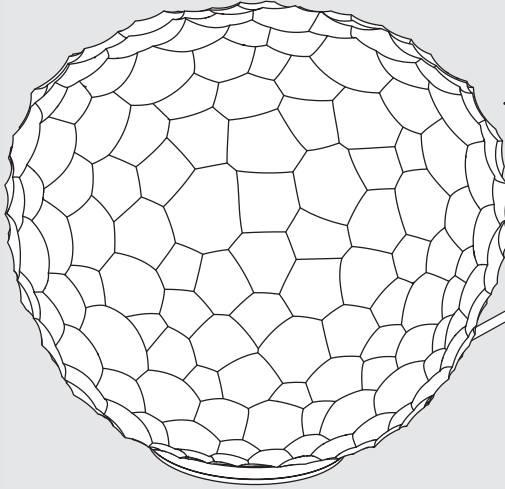

MAX 150W - E27

Halo: HSGST - 2900 lm

LED: DRAA - 2500 lm

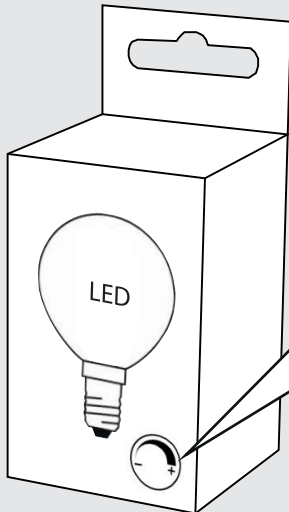

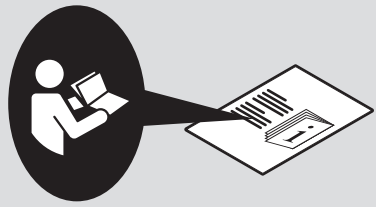

Artemide®



Artemide

via Bergamo, 18
20010 Pregnana M.se (MI)
ITALIA

tel. +39 02 935 181
fax +39 02 935 90 254
fax +39 02 935 90 496

www.artemide.com

VAT IT00846890150

cod. Y513000577

Artemide®

Meteorite 48

design
Pio & Tito Toso

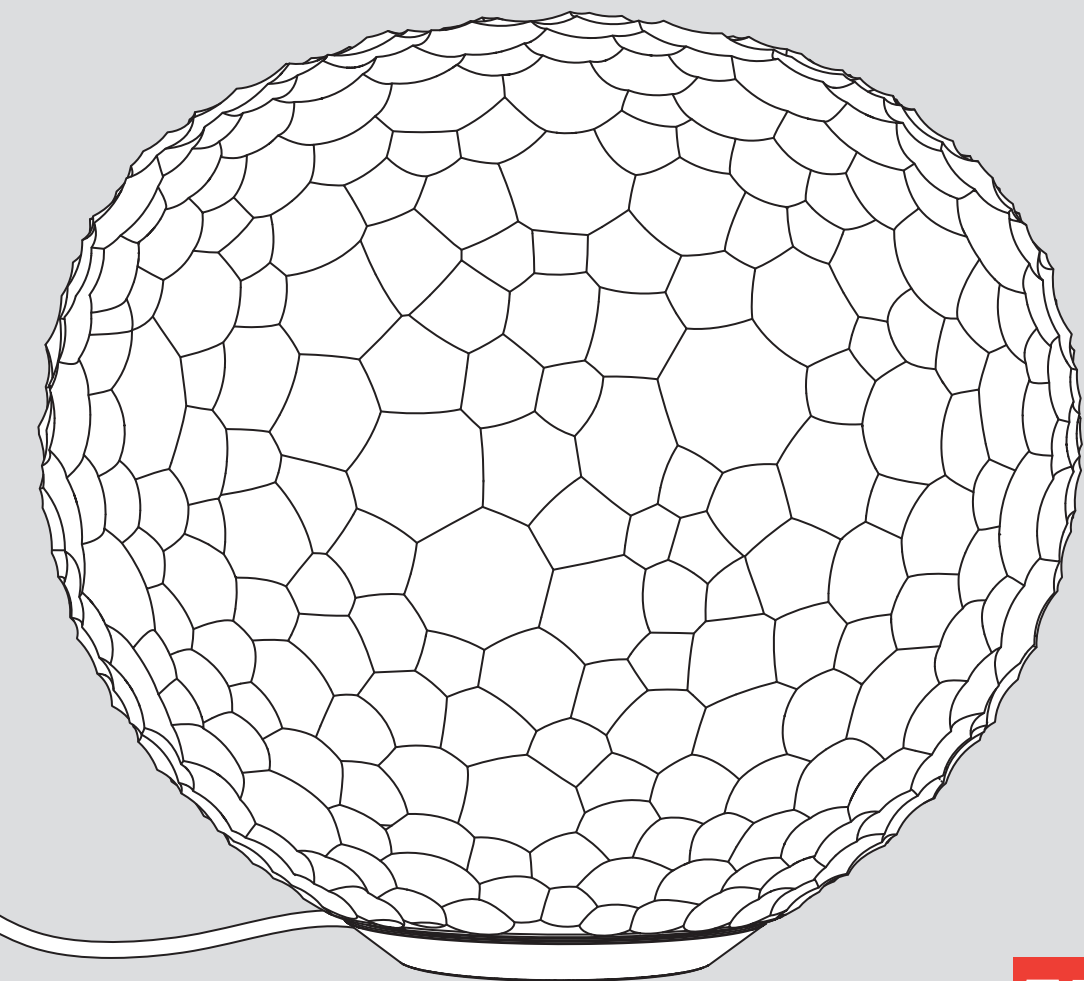



i

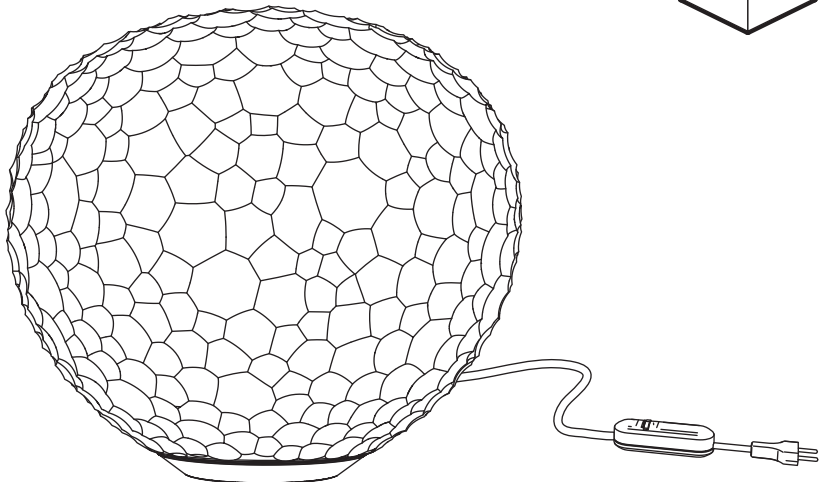
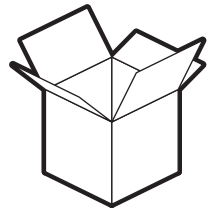
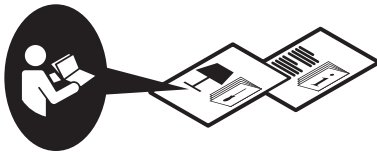
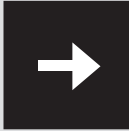
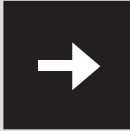
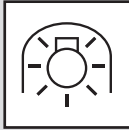
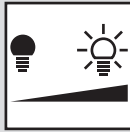
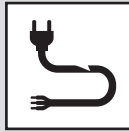
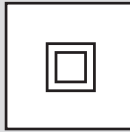

1

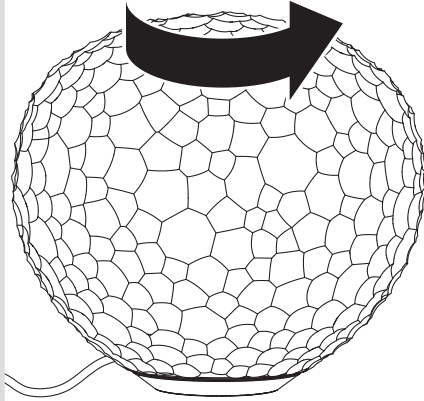

2

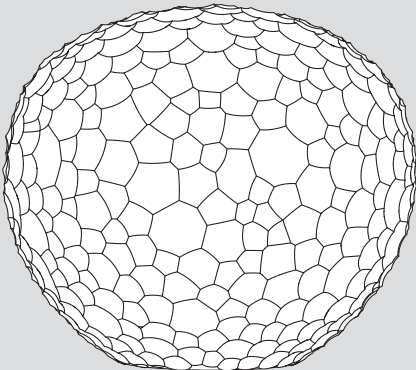
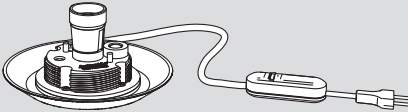
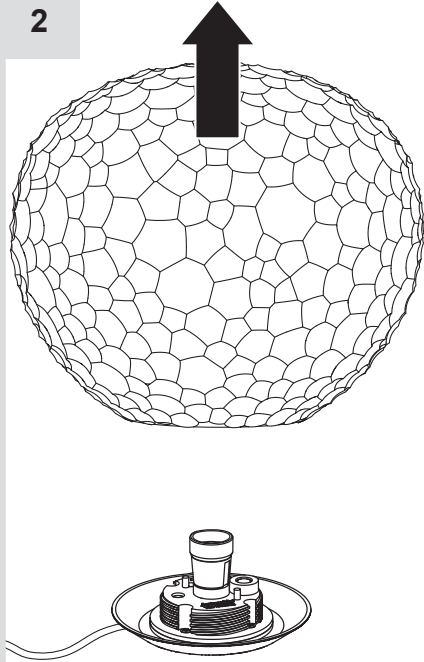

3

E27 - MAX 150W

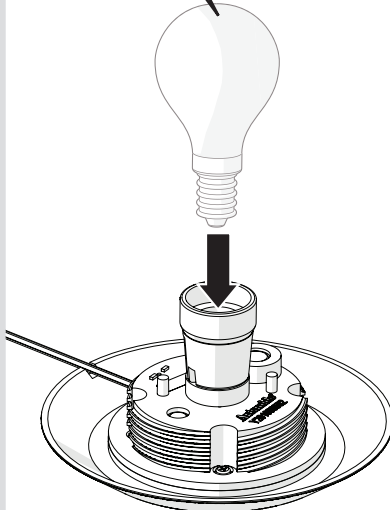

4

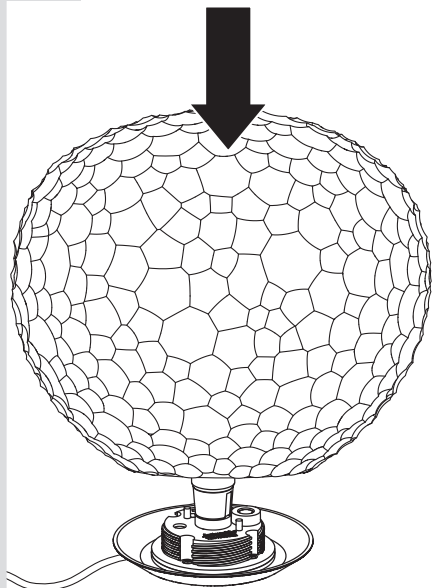

5

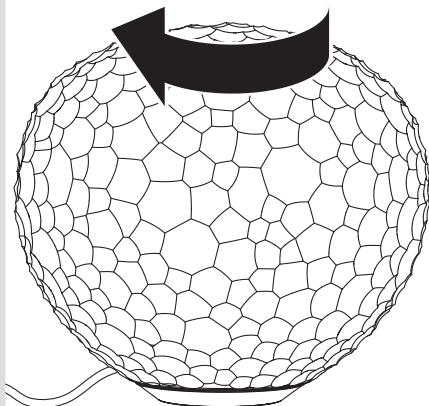

6

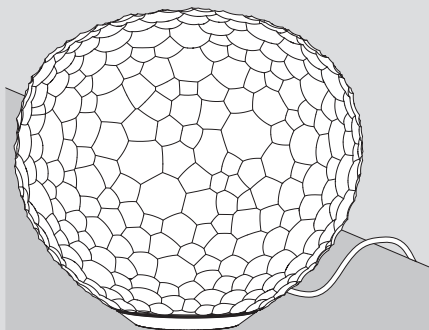
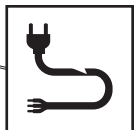
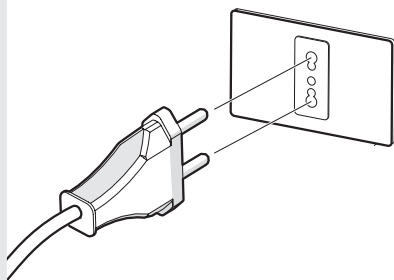



7a

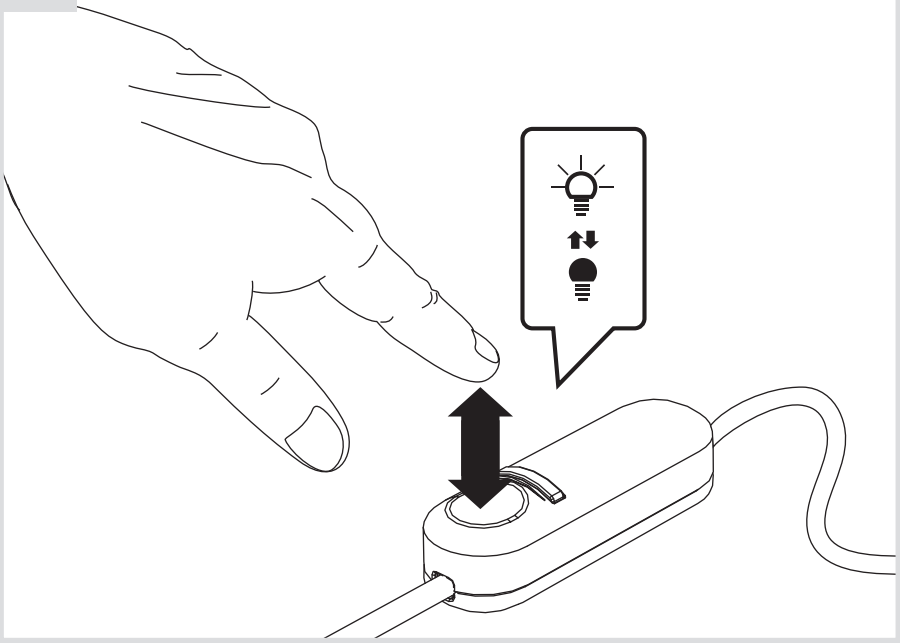

7b

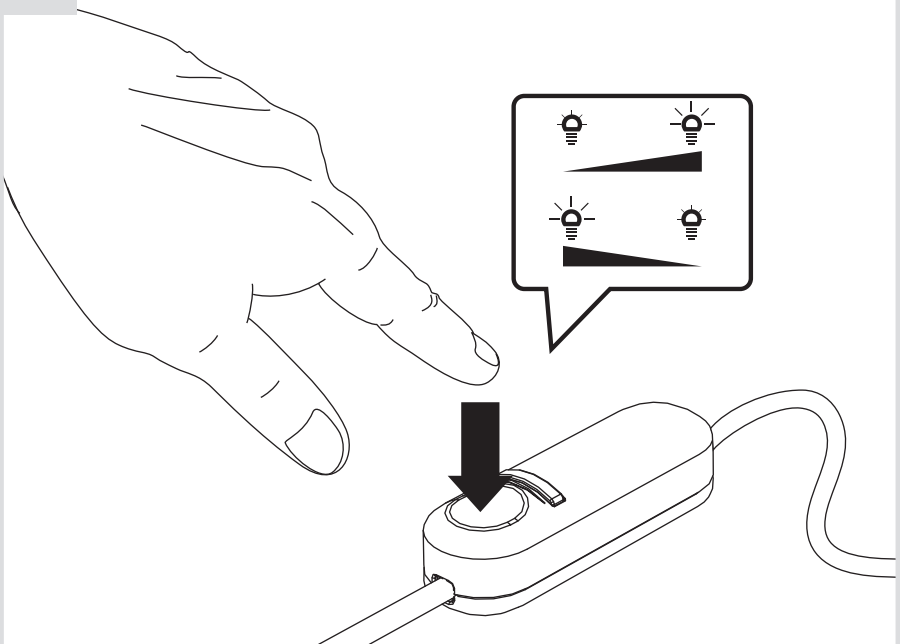



i



1

2

3

4

5

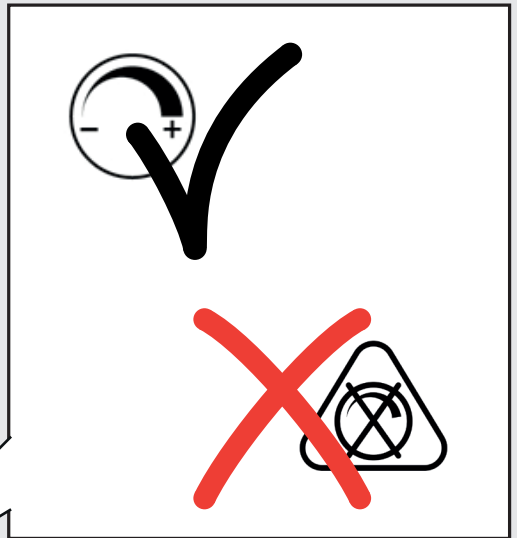
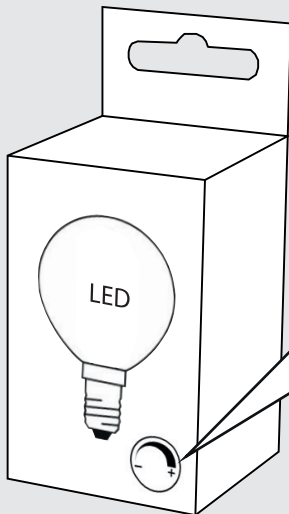
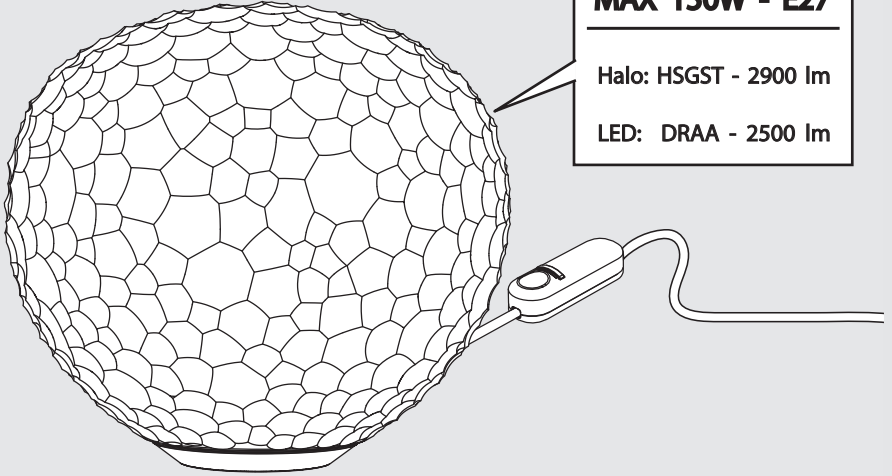

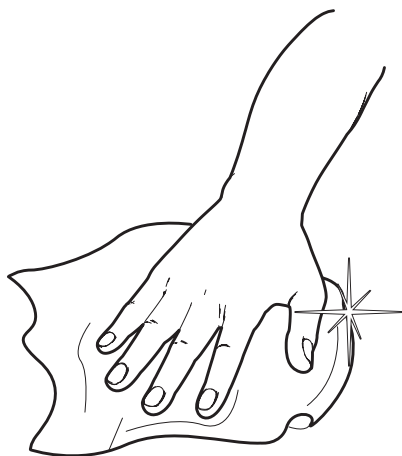

Artemide®

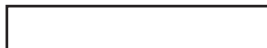

Artemide

via Bergamo, 18
20010 Pregnana M.se (MI)
ITALIA

tel. +39 02 935 181
fax +39 02 935 90 254
fax +39 02 935 90 496

www.artemide.com

VAT IT00846890150

cod. Y513000570