

LUX CEILING TRIM

LUX is a collection of high-performance spots for outdoor applications.

Lux Ceiling is suitable for downlight lighting. It can be installed in plasterboard or wooden ceiling and guarantees a direct and homogeneous lighting. It is available in different finishes, color temperatures and beam angles. 1,2W and 12W



CEILING 12W | 2700° - 14°

LAMPING

Source	LED
Total power	12W
Emission	14°
Switching	according to driver
Tension	350mA
Color temperature	2700K
Luminous flux	1040lm
Initial luminaire efficacy	87lm/W
Initial chromaticity	SDCM<3
Typ CRI	>90
Energy class	F
IP class	65
Dimensions	Ø12,4x8,8
Materials	Aluminium
Ambient temperature range	-20°C/35°C
Performance ambient temperature	25°C
Notes	UGR<19
Net lamp weight	0,81 kg

Codes

BLUC0201N43DAA
BLUC0201N43DAN

Structure

grey
black

PACKAGE

Package 01 Dimension: 23,5x15x11 cm / Gross weight: 1,18 kg

Certificazioni



LUX CEILING TRIM 12W

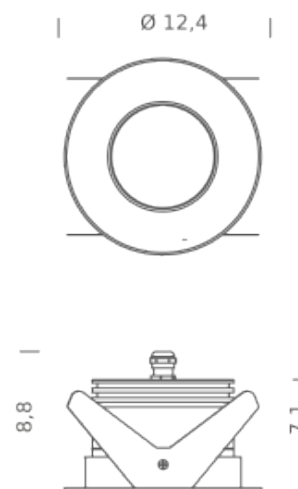

LUX CEILING TRIM 1,2



CEILING 12W | 2700° - 53°

LAMPING

Source	LED
Total power	12W
Emission	53°
Switching	according to driver
Tension	350mA
Color temperature	2700K
Luminous flux	900lm
Initial luminaire efficacy	75lm/W
Initial chromaticity	SDCM<3
Typ CRI	>90
Energy class	F
IP class	65
Dimensions	Ø12,4x8,8
Materials	Aluminium
Ambient temperature range	-20°C/35°C
Performance ambient temperature	25°C
Notes	UGR<19
Net lamp weight	0,81 kg

Codes

BLUC0201H43DAA
BLUC0201H43DAN

Structure

grey
black

PACKAGE

Package 01 Dimension: 23,5x15x11 cm / Gross weight: 1,18 kg

Certificazioni



LUX CEILING TRIM 12W

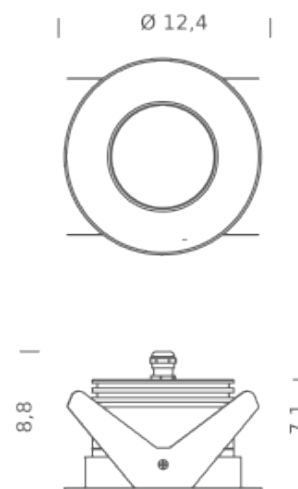

LUX CEILING TRIM 1,2



CEILING 12W | 3000° - 14°

LAMPING

Source	LED
Total power	12W
Emission	14°
Switching	according to driver
Tension	350mA
Color temperature	3000K
Luminous flux	1100lm
Initial luminaire efficacy	92lm/W
Initial chromaticity	SDCM<3
Typ CRI	>90
Energy class	F
IP class	65
Dimensions	Ø12,4x8,8
Materials	Aluminium
Ambient temperature range	-20°C/35°C
Performance ambient temperature	25°C
Notes	UGR<19
Net lamp weight	0,81 kg

Codes

BLUC0201N43WAA
BLUC0201N43WAN

Structure

grey
black

PACKAGE

Package 01 Dimension: 23,5x15x11 cm / Gross weight: 1,18 kg

Certificazioni



LUX CEILING TRIM 12W

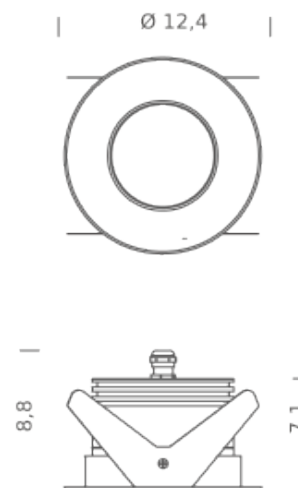

LUX CEILING TRIM 1,2



CEILING 12W | 3000° - 53°

LAMPING

Total power	12W
Emission	53°
Switching	according to driver
Tension	350mA
Color temperature	3000K
Luminous flux	950lm
Initial luminaire efficacy	80lm/W
Initial chromaticity	SDCM<3
Typ CRI	>90
Energy class	F
IP class	65
Dimensions	Ø12,4x8,8
Materials	Aluminium
Ambient temperature range	-20°C/35°C
Performance ambient temperature	25°C
Notes	UGR<19
Net lamp weight	0,81 kg

Codes

BLUC0201H43WAA
BLUC0201H43WAN

Structure

grey
black

PACKAGE

Package 01 Dimension: 23,5x15x11 cm / Gross weight: 1,18 kg

Certificazioni



LUX CEILING TRIM 12W

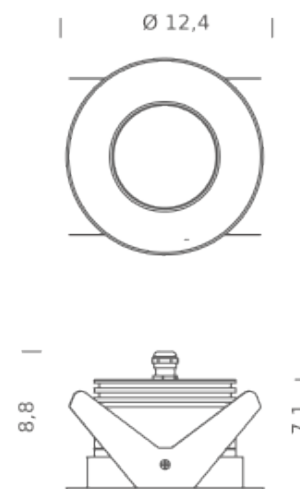

LUX CEILING TRIM 1,2



CEILING 12W | 4000° - 14°

LAMPING

Source	LED
Total power	12W
Emission	14°
Switching	according to driver
Tension	350mA
Color temperature	4000K
Luminous flux	1200lm
Initial luminaire efficacy	100lm/W
Initial chromaticity	SDCM<3
Typ CRI	>90
Energy class	F
IP class	65
Dimensions	Ø12,4x8,8
Materials	Aluminium
Ambient temperature range	-20°C/35°C
Performance ambient temperature	25°C
Notes	UGR<19
Net lamp weight	0,81 kg

Codes

BLUC0201N43NAA
BLUC0201N43NAN

Structure

grey
black

PACKAGE

Package 01 Dimension: 23,5x15x11 cm / Gross weight: 1,18 kg

Certificazioni

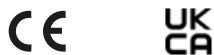

LUX CEILING TRIM 12W

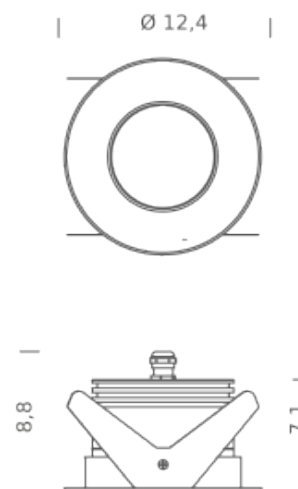

LUX CEILING TRIM 1,2



CEILING 12W | 4000° - 53°

LAMPING

Source	LED
Total power	12W
Emission	53°
Switching	according to driver
Tension	350mA
Color temperature	4000K
Luminous flux	1050lm
Initial luminaire efficacy	88lm/W
Initial chromaticity	SDCM<3
Typ CRI	>90
Energy class	F
IP class	65
Dimensions	Ø12,4x8,8
Materials	Aluminium
Ambient temperature range	-20°C/35°C
Performance ambient temperature	25°C
Notes	UGR<19
Net lamp weight	0,81 kg

Codes

BLUC0201H43NAA
BLUC0201H43NAN

Structure

grey
black

PACKAGE

Package 01 Dimension: 23,5x15x11 cm / Gross weight: 1,18 kg

Certificazioni



LUX CEILING TRIM 12W

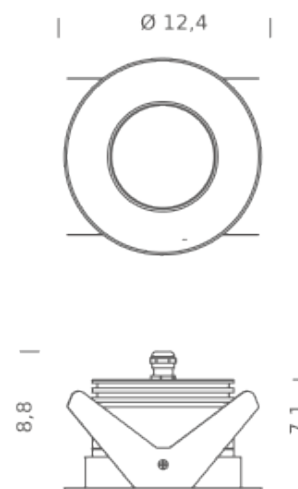

LUX CEILING TRIM 1,2

