

# Alphabet of Light - Lowercase - Letter a

BIG - Bjarke Ingels Group

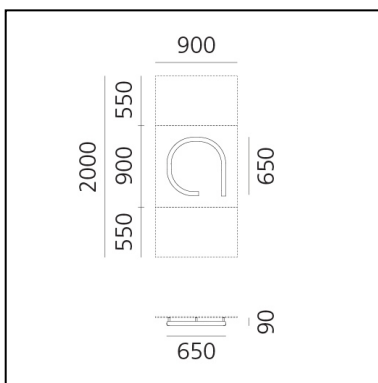

## LUMINAIRE

- Watt: **22W**
- Delivered lumen output: **1971lm**
- CCT: **3000K**
- Efficiency: **88%**
- Efficacy: **89.60lm/W**
- CRI: **80**

## Accessories

NO  
IMAGE  
AVAILABLE

Alphabet of Light -  
Lowercase - Support  
Letter a 1212a00A

## DESCRIPTION

Alphabet of light is a language based on light intended to convey freedom, an elementary principle generating an open system. BIG starts from an abacus of essential geometries to design a new font that translates into light, an alphabet used to write and to express one's thoughts, a tool to give shape to spaces. It allows to design light in space with words, as well as with graphic signs. Two linear elements of different lengths and two round ones are combined with a system of letters, numbers, and symbols. The round elements, available in two diameters, can be separated into modules to join the linear elements together according to different angles, thus designing everchanging geometries. These simple base modules, with specific geometric proportions, can be combined with each other to create countless basic or more complex, linear or curved structures of light, thus producing suspension appliances matching with architectures or space functions. The idea of BIG joins the optoelectronic competence of Artemide to define an innovative construction principle and provide continuous and comfortable lighting. While it has a minimal presence, it encloses groundbreaking patented optoelectronic and mechanical innovation.

## FEATURES

- Product Code: **1202a00A**
- Colour: **White**
- Installation: **Wall**
- Material: **Aluminum support, frosted technopolymer diffuser element.**
- Series: **Design Collection**
- Environment: **Indoor**
- Emission: **Direct/indirect**
- design by: **BIG - Bjarke Ingels Group**

## DIMENSIONS

- Length: **650 mm**
- Height: **650 mm**

# Alphabet of Light - Lowercase - Letter b

BIG - Bjarke Ingels Group

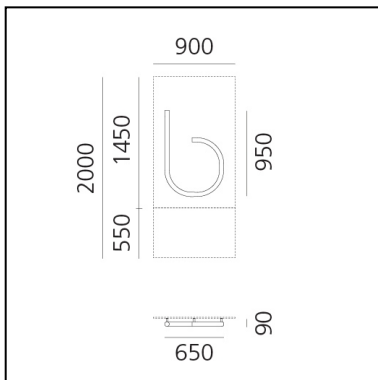
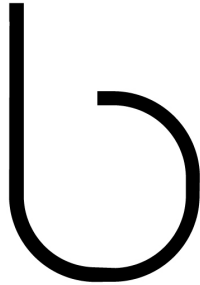

## LUMINAIRE

- Watt: **26W**
- Delivered lumen output: **2295lm**
- CCT: **3000K**
- Efficiency: **88%**
- Efficacy: **88.28lm/W**
- CRI: **80**

## Accessories

NO  
IMAGE  
AVAILABLE

Alphabet of Light -  
Lowercase - Support  
Letter b 1212b00A

## DESCRIPTION

Alphabet of light is a language based on light intended to convey freedom, an elementary principle generating an open system. BIG starts from an abacus of essential geometries to design a new font that translates into light, an alphabet used to write and to express one's thoughts, a tool to give shape to spaces. It allows to design light in space with words, as well as with graphic signs. Two linear elements of different lengths and two round ones are combined with a system of letters, numbers, and symbols. The round elements, available in two diameters, can be separated into modules to join the linear elements together according to different angles, thus designing everchanging geometries. These simple base modules, with specific geometric proportions, can be combined with each other to create countless basic or more complex, linear or curved structures of light, thus producing suspension appliances matching with architectures or space functions. The idea of BIG joins the optoelectronic competence of Artemide to define an innovative construction principle and provide continuous and comfortable lighting. While it has a minimal presence, it encloses groundbreaking patented optoelectronic and mechanical innovation.

## FEATURES

- Product Code: **1202b00A**
- Colour: **White**
- Installation: **Wall**
- Material: **Aluminum support, frosted technopolymer diffuser element.**
- Series: **Design Collection**
- Environment: **Indoor**
- Emission: **Direct/indirect**
- design by: **BIG - Bjarke Ingels Group**

## DIMENSIONS

- Length: **650 mm**
- Height: **950 mm**

# Alphabet of Light - Lowercase - Letter c

BIG - Bjarke Ingels Group

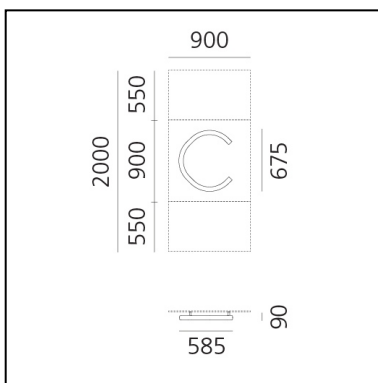
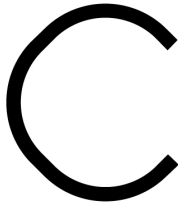

## LUMINAIRE

- Watt: **18W**
- Delivered lumen output: **1638lm**
- CCT: **3000K**
- Efficiency: **88%**
- Efficacy: **91.01lm/W**
- CRI: **80**

## Accessories

NO  
IMAGE  
AVAILABLE

Alphabet of Light -  
Lowercase - Support  
Letter c 1212c00A

## DESCRIPTION

Alphabet of light is a language based on light intended to convey freedom, an elementary principle generating an open system. BIG starts from an abacus of essential geometries to design a new font that translates into light, an alphabet used to write and to express one's thoughts, a tool to give shape to spaces. It allows to design light in space with words, as well as with graphic signs. Two linear elements of different lengths and two round ones are combined with a system of letters, numbers, and symbols. The round elements, available in two diameters, can be separated into modules to join the linear elements together according to different angles, thus designing everchanging geometries. These simple base modules, with specific geometric proportions, can be combined with each other to create countless basic or more complex, linear or curved structures of light, thus producing suspension appliances matching with architectures or space functions. The idea of BIG joins the optoelectronic competence of Artemide to define an innovative construction principle and provide continuous and comfortable lighting. While it has a minimal presence, it encloses groundbreaking patented optoelectronic and mechanical innovation.

## FEATURES

- Product Code: **1202c00A**
- Colour: **White**
- Installation: **Wall**
- Material: **Aluminum support, frosted technopolymer diffuser element.**
- Series: **Design Collection**
- Environment: **Indoor**
- Emission: **Direct/indirect**
- design by: **BIG - Bjarke Ingels Group**

## DIMENSIONS

- Length: **650 mm**
- Height: **650 mm**

# Alphabet of Light - Lowercase - Letter d

BIG - Bjarke Ingels Group

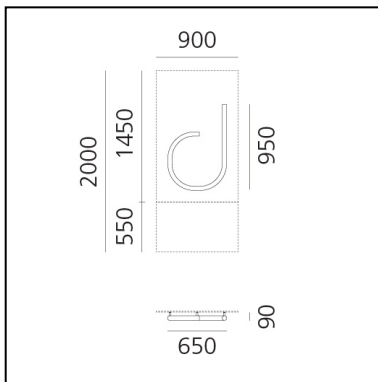
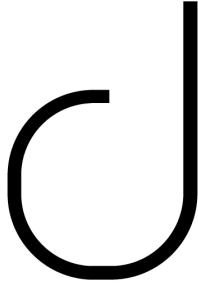

## LUMINAIRE

- Watt: **26W**
- Delivered lumen output: **2295lm**
- CCT: **3000K**
- Efficiency: **88%**
- Efficacy: **88.28lm/W**
- CRI: **80**

## Accessories

NO  
IMAGE  
AVAILABLE

Alphabet of Light -  
Lowercase - Support  
Letter d 1212d00A

## DESCRIPTION

Alphabet of light is a language based on light intended to convey freedom, an elementary principle generating an open system. BIG starts from an abacus of essential geometries to design a new font that translates into light, an alphabet used to write and to express one's thoughts, a tool to give shape to spaces. It allows to design light in space with words, as well as with graphic signs. Two linear elements of different lengths and two round ones are combined with a system of letters, numbers, and symbols. The round elements, available in two diameters, can be separated into modules to join the linear elements together according to different angles, thus designing everchanging geometries. These simple base modules, with specific geometric proportions, can be combined with each other to create countless basic or more complex, linear or curved structures of light, thus producing suspension appliances matching with architectures or space functions. The idea of BIG joins the optoelectronic competence of Artemide to define an innovative construction principle and provide continuous and comfortable lighting. While it has a minimal presence, it encloses groundbreaking patented optoelectronic and mechanical innovation.

## FEATURES

- Product Code: **1202d00A**
- Colour: **White**
- Installation: **Wall**
- Material: **Aluminum support, frosted technopolymer diffuser element.**
- Series: **Design Collection**
- Environment: **Indoor**
- Emission: **Direct/indirect**
- design by: **BIG - Bjarke Ingels Group**

## DIMENSIONS

- Length: **650 mm**
- Height: **950 mm**

# Alphabet of Light - Lowercase - Letter e

BIG - Bjarke Ingels Group

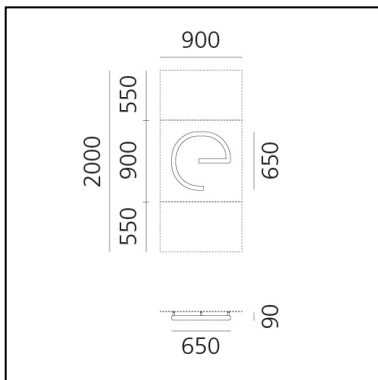
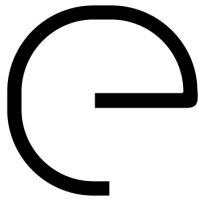

## LUMINAIRE

- Watt: **22W**
- Delivered lumen output: **1971lm**
- CCT: **3000K**
- Efficiency: **88%**
- Efficacy: **89.60lm/W**
- CRI: **80**

## Accessories

NO  
IMAGE  
AVAILABLE

Alphabet of Light -  
Lowercase - Support  
Letter e 1212e00A

## DESCRIPTION

Alphabet of light is a language based on light intended to convey freedom, an elementary principle generating an open system. BIG starts from an abacus of essential geometries to design a new font that translates into light, an alphabet used to write and to express one's thoughts, a tool to give shape to spaces. It allows to design light in space with words, as well as with graphic signs. Two linear elements of different lengths and two round ones are combined with a system of letters, numbers, and symbols. The round elements, available in two diameters, can be separated into modules to join the linear elements together according to different angles, thus designing everchanging geometries. These simple base modules, with specific geometric proportions, can be combined with each other to create countless basic or more complex, linear or curved structures of light, thus producing suspension appliances matching with architectures or space functions. The idea of BIG joins the optoelectronic competence of Artemide to define an innovative construction principle and provide continuous and comfortable lighting. While it has a minimal presence, it encloses groundbreaking patented optoelectronic and mechanical innovation.

## FEATURES

- Product Code: **1202e00A**
- Colour: **White**
- Installation: **Wall**
- Material: **Aluminum support, frosted technopolymer diffuser element.**
- Series: **Design Collection**
- Environment: **Indoor**
- Emission: **Direct/indirect**
- design by: **BIG - Bjarke Ingels Group**

## DIMENSIONS

- Length: **650 mm**
- Height: **650 mm**

# Alphabet of Light - Lowercase - Letter f

BIG - Bjarke Ingels Group

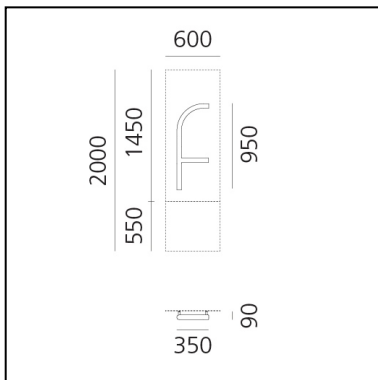
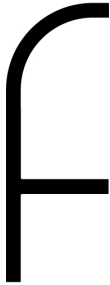

## LUMINAIRE

- Watt: **18W**
- Delivered lumen output: **1557lm**
- CCT: **3000K**
- Efficiency: **88%**
- Efficacy: **86.51lm/W**
- CRI: **80**

## Accessories

NO  
IMAGE  
AVAILABLE

Alphabet of Light -  
Lowercase - Support  
Letter f 1212f00A

## DESCRIPTION

Alphabet of light is a language based on light intended to convey freedom, an elementary principle generating an open system. BIG starts from an abacus of essential geometries to design a new font that translates into light, an alphabet used to write and to express one's thoughts, a tool to give shape to spaces. It allows to design light in space with words, as well as with graphic signs. Two linear elements of different lengths and two round ones are combined with a system of letters, numbers, and symbols. The round elements, available in two diameters, can be separated into modules to join the linear elements together according to different angles, thus designing everchanging geometries. These simple base modules, with specific geometric proportions, can be combined with each other to create countless basic or more complex, linear or curved structures of light, thus producing suspension appliances matching with architectures or space functions. The idea of BIG joins the optoelectronic competence of Artemide to define an innovative construction principle and provide continuous and comfortable lighting. While it has a minimal presence, it encloses groundbreaking patented optoelectronic and mechanical innovation.

## FEATURES

- Product Code: **1202f00A**
- Colour: **White**
- Installation: **Wall**
- Material: **Aluminum support, frosted technopolymer diffuser element.**
- Series: **Design Collection**
- Environment: **Indoor**
- Emission: **Direct/indirect**
- design by: **BIG - Bjarke Ingels Group**

## DIMENSIONS

- Length: **350 mm**
- Height: **950 mm**

# Alphabet of Light - Lowercase - Letter g

BIG - Bjarke Ingels Group

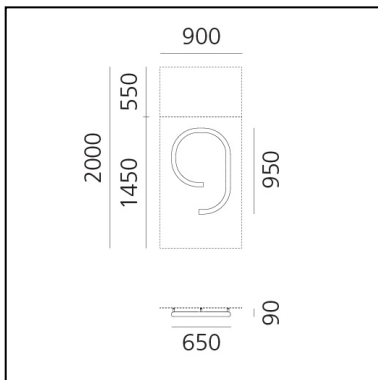
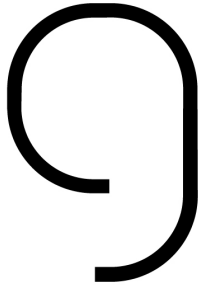

## LUMINAIRE

- Watt: **28W**
- Delivered lumen output: **2502lm**
- CCT: **3000K**
- Efficiency: **88%**
- Efficacy: **89.36lm/W**
- CRI: **80**

## Accessories

NO  
IMAGE  
AVAILABLE

Alphabet of Light -  
Lowercase - Support  
Letter g 1212g00A

## DESCRIPTION

Alphabet of light is a language based on light intended to convey freedom, an elementary principle generating an open system. BIG starts from an abacus of essential geometries to design a new font that translates into light, an alphabet used to write and to express one's thoughts, a tool to give shape to spaces. It allows to design light in space with words, as well as with graphic signs. Two linear elements of different lengths and two round ones are combined with a system of letters, numbers, and symbols. The round elements, available in two diameters, can be separated into modules to join the linear elements together according to different angles, thus designing everchanging geometries. These simple base modules, with specific geometric proportions, can be combined with each other to create countless basic or more complex, linear or curved structures of light, thus producing suspension appliances matching with architectures or space functions. The idea of BIG joins the optoelectronic competence of Artemide to define an innovative construction principle and provide continuous and comfortable lighting. While it has a minimal presence, it encloses groundbreaking patented optoelectronic and mechanical innovation.

## FEATURES

- Product Code: **1202g00A**
- Colour: **White**
- Installation: **Wall**
- Material: **Aluminum support, frosted technopolymer diffuser element.**
- Series: **Design Collection**
- Environment: **Indoor**
- Emission: **Direct/indirect**
- design by: **BIG - Bjarke Ingels Group**

## DIMENSIONS

- Length: **650 mm**
- Height: **950 mm**

# Alphabet of Light - Lowercase - Letter h

BIG - Bjarke Ingels Group

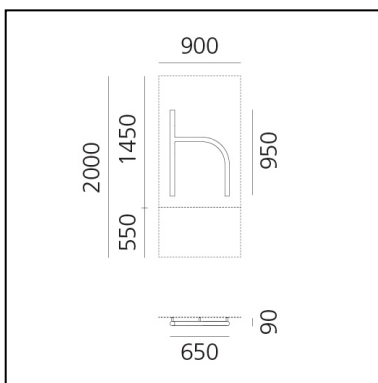
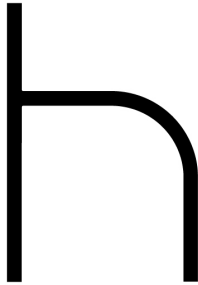

## LUMINAIRE

- Watt: **26W**
- Delivered lumen output: **2214lm**
- CCT: **3000K**
- Efficiency: **88%**
- Efficacy: **85.16lm/W**
- CRI: **80**

## Accessories

NO  
IMAGE  
AVAILABLE

Alphabet of Light -  
Lowercase - Support  
Letter h 1212h00A

## DESCRIPTION

Alphabet of light is a language based on light intended to convey freedom, an elementary principle generating an open system. BIG starts from an abacus of essential geometries to design a new font that translates into light, an alphabet used to write and to express one's thoughts, a tool to give shape to spaces. It allows to design light in space with words, as well as with graphic signs. Two linear elements of different lengths and two round ones are combined with a system of letters, numbers, and symbols. The round elements, available in two diameters, can be separated into modules to join the linear elements together according to different angles, thus designing everchanging geometries. These simple base modules, with specific geometric proportions, can be combined with each other to create countless basic or more complex, linear or curved structures of light, thus producing suspension appliances matching with architectures or space functions. The idea of BIG joins the optoelectronic competence of Artemide to define an innovative construction principle and provide continuous and comfortable lighting. While it has a minimal presence, it encloses groundbreaking patented optoelectronic and mechanical innovation.

## FEATURES

- Product Code: **1202h00A**
- Colour: **White**
- Installation: **Wall**
- Material: **Aluminum support, frosted technopolymer diffuser element.**
- Series: **Design Collection**
- Environment: **Indoor**
- Emission: **Direct/indirect**
- design by: **BIG - Bjarke Ingels Group**

## DIMENSIONS

- Length: **650 mm**
- Height: **950 mm**



# Alphabet of Light - Lowercase - Letter i

BIG - Bjarke Ingels Group

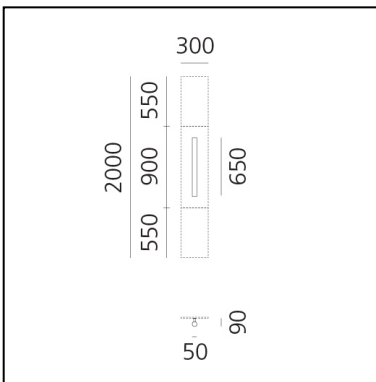

## LUMINAIRE

- Watt: **8W**
- Delivered lumen output: **684lm**
- CCT: **3000K**
- Efficiency: **88%**
- Efficacy: **85.50lm/W**
- CRI: **80**

## Accessories

NO  
IMAGE  
AVAILABLE

Alphabet of Light -  
Lowercase - Support  
Letter i 1212i00A

## DESCRIPTION

Alphabet of light is a language based on light intended to convey freedom, an elementary principle generating an open system. BIG starts from an abacus of essential geometries to design a new font that translates into light, an alphabet used to write and to express one's thoughts, a tool to give shape to spaces. It allows to design light in space with words, as well as with graphic signs. Two linear elements of different lengths and two round ones are combined with a system of letters, numbers, and symbols. The round elements, available in two diameters, can be separated into modules to join the linear elements together according to different angles, thus designing everchanging geometries. These simple base modules, with specific geometric proportions, can be combined with each other to create countless basic or more complex, linear or curved structures of light, thus producing suspension appliances matching with architectures or space functions. The idea of BIG joins the optoelectronic competence of Artemide to define an innovative construction principle and provide continuous and comfortable lighting. While it has a minimal presence, it encloses groundbreaking patented optoelectronic and mechanical innovation.

## FEATURES

- Product Code: **1202i00A**
- Colour: **White**
- Installation: **Wall**
- Material: **Aluminum support, frosted technopolymer diffuser element.**
- Series: **Design Collection**
- Environment: **Indoor**
- Emission: **Direct/indirect**
- design by: **BIG - Bjarke Ingels Group**

## DIMENSIONS

- Length: **50 mm**
- Height: **650 mm**

# Alphabet of Light - Lowercase - Letter j

BIG - Bjarke Ingels Group

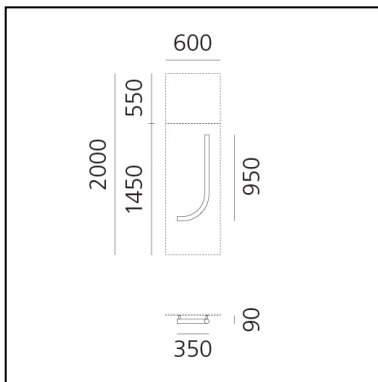

## LUMINAIRE

- Watt: **14W**
- Delivered lumen output: **1215lm**
- CCT: **3000K**
- Efficiency: **88%**
- Efficacy: **86.79lm/W**
- CRI: **80**

## Accessories

NO  
IMAGE  
AVAILABLE

Alphabet of Light -  
Lowercase - Support  
Letter J 1212j00A

## DESCRIPTION

Alphabet of light is a language based on light intended to convey freedom, an elementary principle generating an open system. BIG starts from an abacus of essential geometries to design a new font that translates into light, an alphabet used to write and to express one's thoughts, a tool to give shape to spaces. It allows to design light in space with words, as well as with graphic signs. Two linear elements of different lengths and two round ones are combined with a system of letters, numbers, and symbols. The round elements, available in two diameters, can be separated into modules to join the linear elements together according to different angles, thus designing everchanging geometries. These simple base modules, with specific geometric proportions, can be combined with each other to create countless basic or more complex, linear or curved structures of light, thus producing suspension appliances matching with architectures or space functions. The idea of BIG joins the optoelectronic competence of Artemide to define an innovative construction principle and provide continuous and comfortable lighting. While it has a minimal presence, it encloses groundbreaking patented optoelectronic and mechanical innovation.

## FEATURES

- Product Code: **1202j00A**
- Colour: **White**
- Installation: **Wall**
- Material: **Aluminum support, frosted technopolymer diffuser element.**
- Series: **Design Collection**
- Environment: **Indoor**
- Emission: **Direct/indirect**
- design by: **BIG - Bjarke Ingels Group**

## DIMENSIONS

- Length: **350 mm**
- Height: **950 mm**

# Alphabet of Light - Lowercase - Letter k

BIG - Bjarke Ingels Group

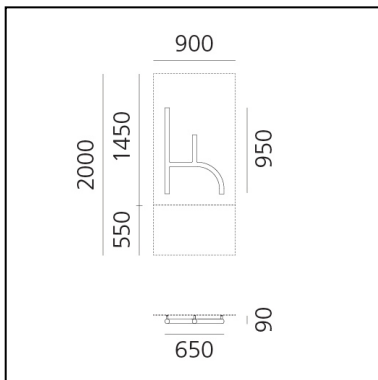
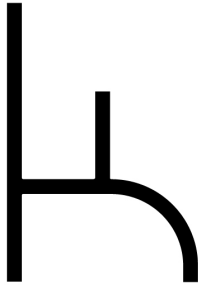

## LUMINAIRE

- Watt: **26W**
- Delivered lumen output: **2223lm**
- CCT: **3000K**
- Efficiency: **88%**
- Efficacy: **85.51lm/W**
- CRI: **80**

## Accessories

NO  
IMAGE  
AVAILABLE

Alphabet of Light -  
Lowercase - Support  
Letter k 1212k00A

## DESCRIPTION

Alphabet of light is a language based on light intended to convey freedom, an elementary principle generating an open system. BIG starts from an abacus of essential geometries to design a new font that translates into light, an alphabet used to write and to express one's thoughts, a tool to give shape to spaces. It allows to design light in space with words, as well as with graphic signs. Two linear elements of different lengths and two round ones are combined with a system of letters, numbers, and symbols. The round elements, available in two diameters, can be separated into modules to join the linear elements together according to different angles, thus designing everchanging geometries. These simple base modules, with specific geometric proportions, can be combined with each other to create countless basic or more complex, linear or curved structures of light, thus producing suspension appliances matching with architectures or space functions. The idea of BIG joins the optoelectronic competence of Artemide to define an innovative construction principle and provide continuous and comfortable lighting. While it has a minimal presence, it encloses groundbreaking patented optoelectronic and mechanical innovation.

## FEATURES

- Product Code: **1202k00A**
- Colour: **White**
- Installation: **Wall**
- Material: **Aluminum support, frosted technopolymer diffuser element.**
- Series: **Design Collection**
- Environment: **Indoor**
- Emission: **Direct/indirect**
- design by: **BIG - Bjarke Ingels Group**

## DIMENSIONS

- Length: **650 mm**
- Height: **950 mm**

# Alphabet of Light - Lowercase - Letter I

BIG - Bjarke Ingels Group

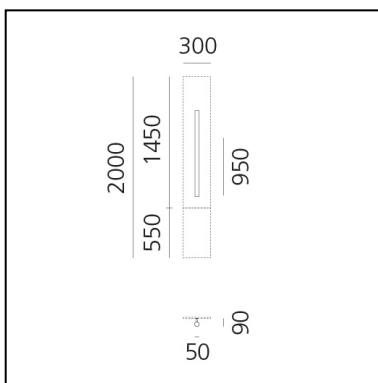

## LUMINAIRE

- Watt: **12W**
- Delivered lumen output: **1008lm**
- CCT: **3000K**
- Efficiency: **88%**
- Efficacy: **84.00lm/W**
- CRI: **80**

## Accessories

NO  
IMAGE  
AVAILABLE

Alphabet of Light -  
Lowercase - Support  
Letter I 1212100A

## DESCRIPTION

Alphabet of light is a language based on light intended to convey freedom, an elementary principle generating an open system. BIG starts from an abacus of essential geometries to design a new font that translates into light, an alphabet used to write and to express one's thoughts, a tool to give shape to spaces. It allows to design light in space with words, as well as with graphic signs. Two linear elements of different lengths and two round ones are combined with a system of letters, numbers, and symbols. The round elements, available in two diameters, can be separated into modules to join the linear elements together according to different angles, thus designing everchanging geometries. These simple base modules, with specific geometric proportions, can be combined with each other to create countless basic or more complex, linear or curved structures of light, thus producing suspension appliances matching with architectures or space functions. The idea of BIG joins the optoelectronic competence of Artemide to define an innovative construction principle and provide continuous and comfortable lighting. While it has a minimal presence, it encloses groundbreaking patented optoelectronic and mechanical innovation.

## FEATURES

- Product Code: **1202100A**
- Colour: **White**
- Installation: **Wall**
- Material: **Aluminum support, frosted technopolymer diffuser element.**
- Series: **Design Collection**
- Environment: **Indoor**
- Emission: **Direct/indirect**
- design by: **BIG - Bjarke Ingels Group**

## DIMENSIONS

- Length: **50 mm**
- Height: **950 mm**

# Alphabet of Light - Lowercase - Letter m

BIG - Bjarke Ingels Group

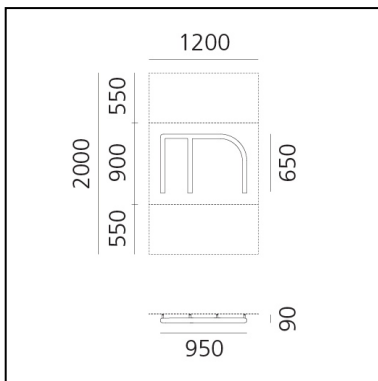
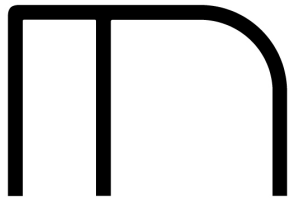

## LUMINAIRE

- Watt: **34W**
- Delivered lumen output: **2862lm**
- CCT: **3000K**
- Efficiency: **88%**
- Efficacy: **84.18lm/W**
- CRI: **80**

## Accessories

NO  
IMAGE  
AVAILABLE

Alphabet of Light -  
Lowercase - Support Letter  
m 1212m00A

## DESCRIPTION

Alphabet of light is a language based on light intended to convey freedom, an elementary principle generating an open system. BIG starts from an abacus of essential geometries to design a new font that translates into light, an alphabet used to write and to express one's thoughts, a tool to give shape to spaces. It allows to design light in space with words, as well as with graphic signs. Two linear elements of different lengths and two round ones are combined with a system of letters, numbers, and symbols. The round elements, available in two diameters, can be separated into modules to join the linear elements together according to different angles, thus designing everchanging geometries. These simple base modules, with specific geometric proportions, can be combined with each other to create countless basic or more complex, linear or curved structures of light, thus producing suspension appliances matching with architectures or space functions. The idea of BIG joins the optoelectronic competence of Artemide to define an innovative construction principle and provide continuous and comfortable lighting. While it has a minimal presence, it encloses groundbreaking patented optoelectronic and mechanical innovation.

## FEATURES

- Product Code: **1202m00A**
- Colour: **White**
- Installation: **Wall**
- Material: **Aluminum support, frosted technopolymer diffuser element.**
- Series: **Design Collection**
- Environment: **Indoor**
- Emission: **Direct/indirect**
- design by: **BIG - Bjarke Ingels Group**

## DIMENSIONS

- Length: **950 mm**
- Height: **650 mm**

# Alphabet of Light - Lowercase - Letter n

BIG - Bjarke Ingels Group

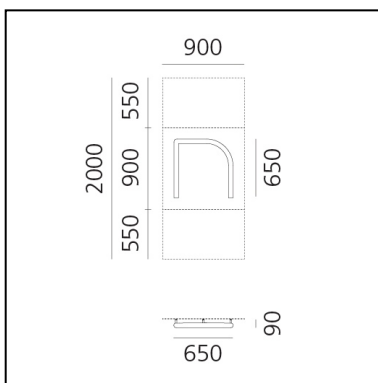
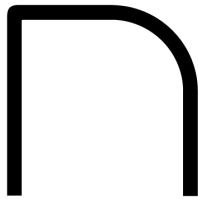

## LUMINAIRE

- Watt: **22W**
- Delivered lumen output: **1872lm**
- CCT: **3000K**
- Efficiency: **88%**
- Efficacy: **85.10lm/W**
- CRI: **80**

## Accessories

NO  
IMAGE  
AVAILABLE

Alphabet of Light -  
Lowercase - Support  
Letter n 1212n00A

## DESCRIPTION

Alphabet of light is a language based on light intended to convey freedom, an elementary principle generating an open system. BIG starts from an abacus of essential geometries to design a new font that translates into light, an alphabet used to write and to express one's thoughts, a tool to give shape to spaces. It allows to design light in space with words, as well as with graphic signs. Two linear elements of different lengths and two round ones are combined with a system of letters, numbers, and symbols. The round elements, available in two diameters, can be separated into modules to join the linear elements together according to different angles, thus designing everchanging geometries. These simple base modules, with specific geometric proportions, can be combined with each other to create countless basic or more complex, linear or curved structures of light, thus producing suspension appliances matching with architectures or space functions. The idea of BIG joins the optoelectronic competence of Artemide to define an innovative construction principle and provide continuous and comfortable lighting. While it has a minimal presence, it encloses groundbreaking patented optoelectronic and mechanical innovation.

## FEATURES

- Product Code: **1202n00A**
- Colour: **White**
- Installation: **Wall**
- Material: **Aluminum support, frosted technopolymer diffuser element.**
- Series: **Design Collection**
- Environment: **Indoor**
- Emission: **Direct/indirect**
- design by: **BIG - Bjarke Ingels Group**

## DIMENSIONS

- Length: **650 mm**
- Height: **650 mm**

# Alphabet of Light - Lowercase - Letter o

BIG - Bjarke Ingels Group

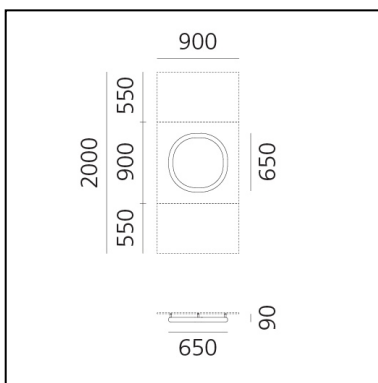
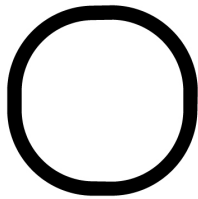

## LUMINAIRE

- Watt: **24W**
- Delivered lumen output: **2160lm**
- CCT: **3000K**
- Efficiency: **88%**
- Efficacy: **90.01lm/W**
- CRI: **80**

## Accessories

NO  
IMAGE  
AVAILABLE

Alphabet of Light -  
Lowercase - Support  
Letter n 1212o00A

## DESCRIPTION

Alphabet of light is a language based on light intended to convey freedom, an elementary principle generating an open system. BIG starts from an abacus of essential geometries to design a new font that translates into light, an alphabet used to write and to express one's thoughts, a tool to give shape to spaces. It allows to design light in space with words, as well as with graphic signs. Two linear elements of different lengths and two round ones are combined with a system of letters, numbers, and symbols. The round elements, available in two diameters, can be separated into modules to join the linear elements together according to different angles, thus designing everchanging geometries. These simple base modules, with specific geometric proportions, can be combined with each other to create countless basic or more complex, linear or curved structures of light, thus producing suspension appliances matching with architectures or space functions. The idea of BIG joins the optoelectronic competence of Artemide to define an innovative construction principle and provide continuous and comfortable lighting. While it has a minimal presence, it encloses groundbreaking patented optoelectronic and mechanical innovation.

## FEATURES

- Product Code: **1202o00A**
- Colour: **White**
- Installation: **Wall**
- Material: **Aluminum support, frosted technopolymer diffuser element.**
- Series: **Design Collection**
- Environment: **Indoor**
- Emission: **Direct/indirect**
- design by: **BIG - Bjarke Ingels Group**

## DIMENSIONS

- Length: **650 mm**
- Height: **650 mm**

# Alphabet of Light - Lowercase - Letter p

BIG - Bjarke Ingels Group

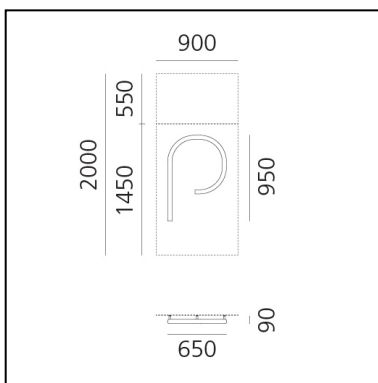
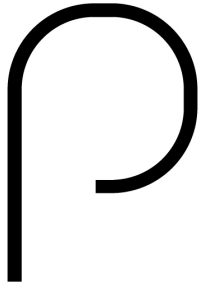

## LUMINAIRE

- Watt: **26W**
- Delivered lumen output: **2295lm**
- CCT: **3000K**
- Efficiency: **88%**
- Efficacy: **88.28lm/W**
- CRI: **80**

## Accessories

NO  
IMAGE  
AVAILABLE

Alphabet of Light -  
Lowercase - Support  
Letter p 1212p00A

## DESCRIPTION

Alphabet of light is a language based on light intended to convey freedom, an elementary principle generating an open system. BIG starts from an abacus of essential geometries to design a new font that translates into light, an alphabet used to write and to express one's thoughts, a tool to give shape to spaces. It allows to design light in space with words, as well as with graphic signs. Two linear elements of different lengths and two round ones are combined with a system of letters, numbers, and symbols. The round elements, available in two diameters, can be separated into modules to join the linear elements together according to different angles, thus designing everchanging geometries. These simple base modules, with specific geometric proportions, can be combined with each other to create countless basic or more complex, linear or curved structures of light, thus producing suspension appliances matching with architectures or space functions. The idea of BIG joins the optoelectronic competence of Artemide to define an innovative construction principle and provide continuous and comfortable lighting. While it has a minimal presence, it encloses groundbreaking patented optoelectronic and mechanical innovation.

## FEATURES

- Product Code: **1202p00A**
- Colour: **White**
- Installation: **Wall**
- Material: **Aluminum support, frosted technopolymer diffuser element.**
- Series: **Design Collection**
- Environment: **Indoor**
- Emission: **Direct/indirect**
- design by: **BIG - Bjarke Ingels Group**

## DIMENSIONS

- Length: **650 mm**
- Height: **950 mm**



# Alphabet of Light - Lowercase - Letter q

BIG - Bjarke Ingels Group

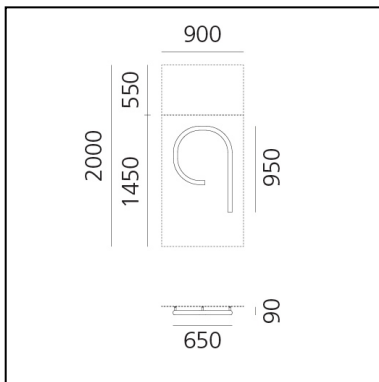
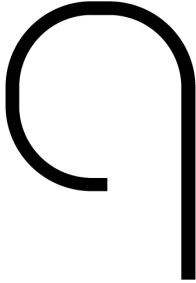

## LUMINAIRE

- Watt: **26W**
- Delivered lumen output: **2295lm**
- CCT: **3000K**
- Efficiency: **88%**
- Efficacy: **88.28lm/W**
- CRI: **80**

## Accessories

NO  
IMAGE  
AVAILABLE

Alphabet of Light -  
Lowercase - Support  
Letter q 1212q00A

## DESCRIPTION

Alphabet of light is a language based on light intended to convey freedom, an elementary principle generating an open system. BIG starts from an abacus of essential geometries to design a new font that translates into light, an alphabet used to write and to express one's thoughts, a tool to give shape to spaces. It allows to design light in space with words, as well as with graphic signs. Two linear elements of different lengths and two round ones are combined with a system of letters, numbers, and symbols. The round elements, available in two diameters, can be separated into modules to join the linear elements together according to different angles, thus designing everchanging geometries. These simple base modules, with specific geometric proportions, can be combined with each other to create countless basic or more complex, linear or curved structures of light, thus producing suspension appliances matching with architectures or space functions. The idea of BIG joins the optoelectronic competence of Artemide to define an innovative construction principle and provide continuous and comfortable lighting. While it has a minimal presence, it encloses groundbreaking patented optoelectronic and mechanical innovation.

## FEATURES

- Product Code: **1202q00A**
- Colour: **White**
- Installation: **Wall**
- Material: **Aluminum support, frosted technopolymer diffuser element.**
- Series: **Design Collection**
- Environment: **Indoor**
- Emission: **Direct/indirect**
- design by: **BIG - Bjarke Ingels Group**

## DIMENSIONS

- Length: **650 mm**
- Height: **950 mm**

# Alphabet of Light - Lowercase - Letter r

BIG - Bjarke Ingels Group

r

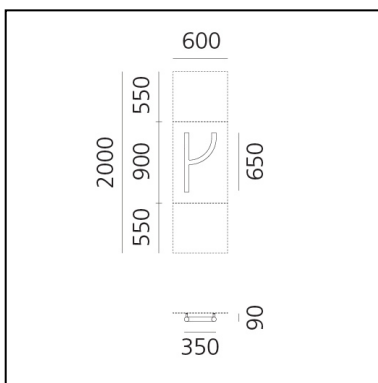

## LUMINAIRE

- Watt: **14W**
- Delivered lumen output: **1233lm**
- CCT: **3000K**
- Efficiency: **88%**
- Efficacy: **88.08lm/W**
- CRI: **80**

## Accessories

NO  
IMAGE  
AVAILABLE

Alphabet of Light -  
Lowercase - Support  
Letter r 1212r00A

## DESCRIPTION

Alphabet of light is a language based on light intended to convey freedom, an elementary principle generating an open system. BIG starts from an abacus of essential geometries to design a new font that translates into light, an alphabet used to write and to express one's thoughts, a tool to give shape to spaces. It allows to design light in space with words, as well as with graphic signs. Two linear elements of different lengths and two round ones are combined with a system of letters, numbers, and symbols. The round elements, available in two diameters, can be separated into modules to join the linear elements together according to different angles, thus designing everchanging geometries. These simple base modules, with specific geometric proportions, can be combined with each other to create countless basic or more complex, linear or curved structures of light, thus producing suspension appliances matching with architectures or space functions. The idea of BIG joins the optoelectronic competence of Artemide to define an innovative construction principle and provide continuous and comfortable lighting. While it has a minimal presence, it encloses groundbreaking patented optoelectronic and mechanical innovation.

## FEATURES

- Product Code: **1202r00A**
- Colour: **White**
- Installation: **Wall**
- Material: **Aluminum support, frosted technopolymer diffuser element.**
- Series: **Design Collection**
- Environment: **Indoor**
- Emission: **Direct/indirect**
- design by: **BIG - Bjarke Ingels Group**

## DIMENSIONS

- Length: **350 mm**
- Height: **650 mm**

# Alphabet of Light - Lowercase - Letter s

BIG - Bjarke Ingels Group

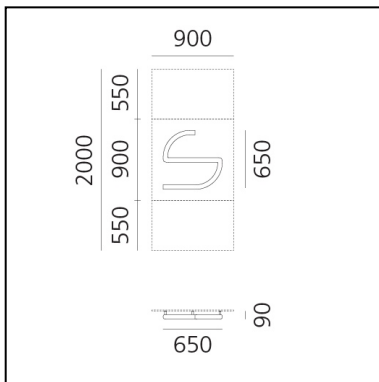
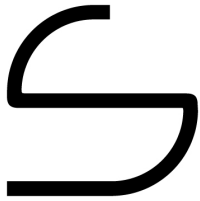

## LUMINAIRE

- Watt: **24W**
- Delivered lumen output: **2079lm**
- CCT: **3000K**
- Efficiency: **88%**
- Efficacy: **86.63lm/W**
- CRI: **80**

## Accessories

NO  
IMAGE  
AVAILABLE

Alphabet of Light -  
Lowercase - Support  
Letter s 1212s00A

## DESCRIPTION

Alphabet of light is a language based on light intended to convey freedom, an elementary principle generating an open system. BIG starts from an abacus of essential geometries to design a new font that translates into light, an alphabet used to write and to express one's thoughts, a tool to give shape to spaces. It allows to design light in space with words, as well as with graphic signs. Two linear elements of different lengths and two round ones are combined with a system of letters, numbers, and symbols. The round elements, available in two diameters, can be separated into modules to join the linear elements together according to different angles, thus designing everchanging geometries. These simple base modules, with specific geometric proportions, can be combined with each other to create countless basic or more complex, linear or curved structures of light, thus producing suspension appliances matching with architectures or space functions. The idea of BIG joins the optoelectronic competence of Artemide to define an innovative construction principle and provide continuous and comfortable lighting. While it has a minimal presence, it encloses groundbreaking patented optoelectronic and mechanical innovation.

## FEATURES

- Product Code: **1202s00A**
- Colour: **White**
- Installation: **Wall**
- Material: **Aluminum support, frosted technopolymer diffuser element.**
- Series: **Design Collection**
- Environment: **Indoor**
- Emission: **Direct/indirect**
- design by: **BIG - Bjarke Ingels Group**

## DIMENSIONS

- Length: **650 mm**
- Height: **650 mm**

# Alphabet of Light - Lowercase - Letter t

BIG - Bjarke Ingels Group

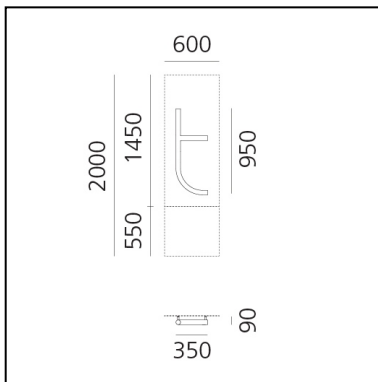
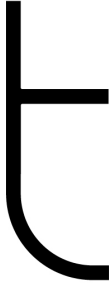

## LUMINAIRE

- Watt: **18W**
- Delivered lumen output: **1557lm**
- CCT: **3000K**
- Efficiency: **88%**
- Efficacy: **86.51lm/W**
- CRI: **80**

## Accessories

NO  
IMAGE  
AVAILABLE

Alphabet of Light -  
Lowercase - Support  
Letter t 1212t00A

## DESCRIPTION

Alphabet of light is a language based on light intended to convey freedom, an elementary principle generating an open system. BIG starts from an abacus of essential geometries to design a new font that translates into light, an alphabet used to write and to express one's thoughts, a tool to give shape to spaces. It allows to design light in space with words, as well as with graphic signs. Two linear elements of different lengths and two round ones are combined with a system of letters, numbers, and symbols. The round elements, available in two diameters, can be separated into modules to join the linear elements together according to different angles, thus designing everchanging geometries. These simple base modules, with specific geometric proportions, can be combined with each other to create countless basic or more complex, linear or curved structures of light, thus producing suspension appliances matching with architectures or space functions. The idea of BIG joins the optoelectronic competence of Artemide to define an innovative construction principle and provide continuous and comfortable lighting. While it has a minimal presence, it encloses groundbreaking patented optoelectronic and mechanical innovation.

## FEATURES

- Product Code: **1202t00A**
- Colour: **White**
- Installation: **Wall**
- Material: **Aluminum support, frosted technopolymer diffuser element.**
- Series: **Design Collection**
- Environment: **Indoor**
- Emission: **Direct/indirect**
- design by: **BIG - Bjarke Ingels Group**

## DIMENSIONS

- Length: **350 mm**
- Height: **950 mm**

# Alphabet of Light - Lowercase - Letter u

BIG - Bjarke Ingels Group

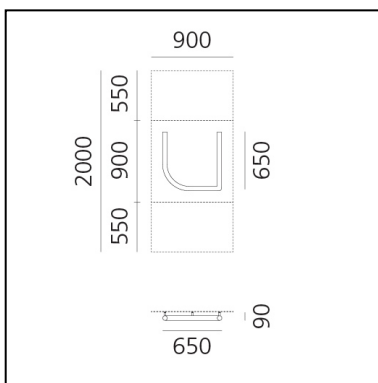
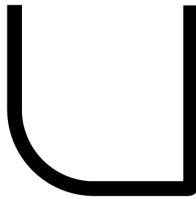

## LUMINAIRE

- Watt: **22W**
- Delivered lumen output: **1872lm**
- CCT: **3000K**
- Efficiency: **88%**
- Efficacy: **85.10lm/W**
- CRI: **80**

## Accessories

NO  
IMAGE  
AVAILABLE

Alphabet of Light -  
Lowercase - Support  
Letter u 1212u00A

## DESCRIPTION

Alphabet of light is a language based on light intended to convey freedom, an elementary principle generating an open system. BIG starts from an abacus of essential geometries to design a new font that translates into light, an alphabet used to write and to express one's thoughts, a tool to give shape to spaces. It allows to design light in space with words, as well as with graphic signs. Two linear elements of different lengths and two round ones are combined with a system of letters, numbers, and symbols. The round elements, available in two diameters, can be separated into modules to join the linear elements together according to different angles, thus designing everchanging geometries. These simple base modules, with specific geometric proportions, can be combined with each other to create countless basic or more complex, linear or curved structures of light, thus producing suspension appliances matching with architectures or space functions. The idea of BIG joins the optoelectronic competence of Artemide to define an innovative construction principle and provide continuous and comfortable lighting. While it has a minimal presence, it encloses groundbreaking patented optoelectronic and mechanical innovation.

## FEATURES

- Product Code: **1202u00A**
- Colour: **White**
- Installation: **Wall**
- Material: **Aluminum support, frosted technopolymer diffuser element.**
- Series: **Design Collection**
- Environment: **Indoor**
- Emission: **Direct/indirect**
- design by: **BIG - Bjarke Ingels Group**

## DIMENSIONS

- Length: **650 mm**
- Height: **650 mm**

# Alphabet of Light - Lowercase - Letter v

BIG - Bjarke Ingels Group

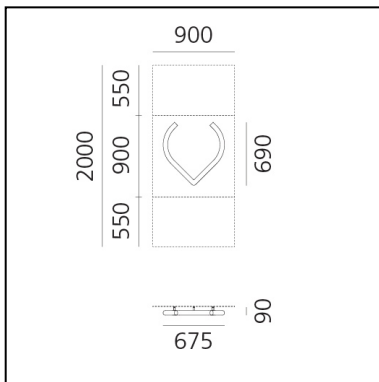
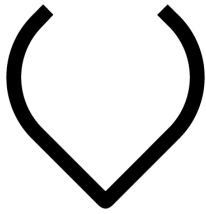

## LUMINAIRE

- Watt: **20W**
- Delivered lumen output: **1746lm**
- CCT: **3000K**
- Efficiency: **88%**
- Efficacy: **87.31lm/W**
- CRI: **80**

## Accessories

NO  
IMAGE  
AVAILABLE

Alphabet of Light -  
Lowercase - Support  
Letter v 1212v00A

## DESCRIPTION

Alphabet of light is a language based on light intended to convey freedom, an elementary principle generating an open system. BIG starts from an abacus of essential geometries to design a new font that translates into light, an alphabet used to write and to express one's thoughts, a tool to give shape to spaces. It allows to design light in space with words, as well as with graphic signs. Two linear elements of different lengths and two round ones are combined with a system of letters, numbers, and symbols. The round elements, available in two diameters, can be separated into modules to join the linear elements together according to different angles, thus designing everchanging geometries. These simple base modules, with specific geometric proportions, can be combined with each other to create countless basic or more complex, linear or curved structures of light, thus producing suspension appliances matching with architectures or space functions. The idea of BIG joins the optoelectronic competence of Artemide to define an innovative construction principle and provide continuous and comfortable lighting. While it has a minimal presence, it encloses groundbreaking patented optoelectronic and mechanical innovation.

## FEATURES

- Product Code: **1202v00A**
- Colour: **White**
- Installation: **Wall**
- Material: **Aluminum support, frosted technopolymer diffuser element.**
- Series: **Design Collection**
- Environment: **Indoor**
- Emission: **Direct/indirect**
- design by: **BIG - Bjarke Ingels Group**

## DIMENSIONS

- Length: **650 mm**
- Height: **650 mm**

# Alphabet of Light - Lowercase - Letter w

BIG - Bjarke Ingels Group

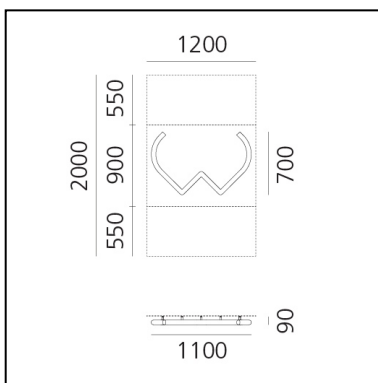

## LUMINAIRE

- Watt: **28W**
- Delivered lumen output: **2394lm**
- CCT: **3000K**
- Efficiency: **88%**
- Efficacy: **85.51lm/W**
- CRI: **80**

## Accessories

NO  
IMAGE  
AVAILABLE

Alphabet of Light -  
Lowercase - Support  
Letter w 1212w00A

## DESCRIPTION

Alphabet of light is a language based on light intended to convey freedom, an elementary principle generating an open system. BIG starts from an abacus of essential geometries to design a new font that translates into light, an alphabet used to write and to express one's thoughts, a tool to give shape to spaces. It allows to design light in space with words, as well as with graphic signs. Two linear elements of different lengths and two round ones are combined with a system of letters, numbers, and symbols. The round elements, available in two diameters, can be separated into modules to join the linear elements together according to different angles, thus designing everchanging geometries. These simple base modules, with specific geometric proportions, can be combined with each other to create countless basic or more complex, linear or curved structures of light, thus producing suspension appliances matching with architectures or space functions. The idea of BIG joins the optoelectronic competence of Artemide to define an innovative construction principle and provide continuous and comfortable lighting. While it has a minimal presence, it encloses groundbreaking patented optoelectronic and mechanical innovation.

## FEATURES

- Product Code: **1202w00A**
- Colour: **White**
- Installation: **Wall**
- Material: **Aluminum support, frosted technopolymer diffuser element.**
- Series: **Design Collection**
- Environment: **Indoor**
- Emission: **Direct/indirect**
- design by: **BIG - Bjarke Ingels Group**

## DIMENSIONS

- Length: **950 mm**
- Height: **650 mm**

# Alphabet of Light - Lowercase - Letter x

BIG - Bjarke Ingels Group

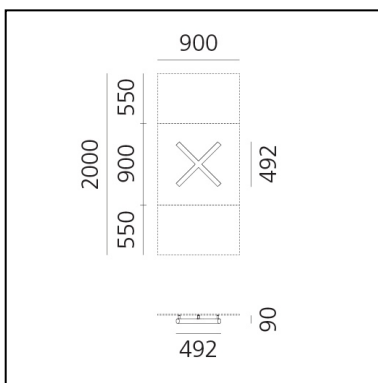

## LUMINAIRE

- Watt: **16W**
- Delivered lumen output: **1368lm**
- CCT: **3000K**
- Efficiency: **88%**
- Efficacy: **85.51lm/W**
- CRI: **80**

## Accessories

NO  
IMAGE  
AVAILABLE

Alphabet of Light -  
Lowercase - Support  
Letter x 1212x00A

## DESCRIPTION

Alphabet of light is a language based on light intended to convey freedom, an elementary principle generating an open system. BIG starts from an abacus of essential geometries to design a new font that translates into light, an alphabet used to write and to express one's thoughts, a tool to give shape to spaces. It allows to design light in space with words, as well as with graphic signs. Two linear elements of different lengths and two round ones are combined with a system of letters, numbers, and symbols. The round elements, available in two diameters, can be separated into modules to join the linear elements together according to different angles, thus designing everchanging geometries. These simple base modules, with specific geometric proportions, can be combined with each other to create countless basic or more complex, linear or curved structures of light, thus producing suspension appliances matching with architectures or space functions. The idea of BIG joins the optoelectronic competence of Artemide to define an innovative construction principle and provide continuous and comfortable lighting. While it has a minimal presence, it encloses groundbreaking patented optoelectronic and mechanical innovation.

## FEATURES

- Product Code: **1202x00A**
- Colour: **White**
- Installation: **Wall**
- Material: **Aluminum support, frosted technopolymer diffuser element.**
- Series: **Design Collection**
- Environment: **Indoor**
- Emission: **Direct/indirect**
- design by: **BIG - Bjarke Ingels Group**

## DIMENSIONS

- Length: **650 mm**
- Height: **650 mm**



# Alphabet of Light - Lowercase - Letter y

BIG - Bjarke Ingels Group

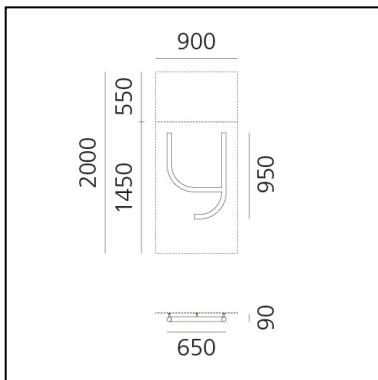
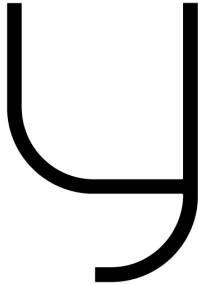

## LUMINAIRE

- Watt: **28W**
- Delivered lumen output: **2421lm**
- CCT: **3000K**
- Efficiency: **88%**
- Efficacy: **86.47lm/W**
- CRI: **80**

## Accessories

NO  
IMAGE  
AVAILABLE

Alphabet of Light -  
Lowercase - Support  
Letter y 1212y00A

## DESCRIPTION

Alphabet of light is a language based on light intended to convey freedom, an elementary principle generating an open system. BIG starts from an abacus of essential geometries to design a new font that translates into light, an alphabet used to write and to express one's thoughts, a tool to give shape to spaces. It allows to design light in space with words, as well as with graphic signs. Two linear elements of different lengths and two round ones are combined with a system of letters, numbers, and symbols. The round elements, available in two diameters, can be separated into modules to join the linear elements together according to different angles, thus designing everchanging geometries. These simple base modules, with specific geometric proportions, can be combined with each other to create countless basic or more complex, linear or curved structures of light, thus producing suspension appliances matching with architectures or space functions. The idea of BIG joins the optoelectronic competence of Artemide to define an innovative construction principle and provide continuous and comfortable lighting. While it has a minimal presence, it encloses groundbreaking patented optoelectronic and mechanical innovation.

## FEATURES

- Product Code: **1202y00A**
- Colour: **White**
- Installation: **Wall**
- Material: **Aluminum support, frosted technopolymer diffuser element.**
- Series: **Design Collection**
- Environment: **Indoor**
- Emission: **Direct/indirect**
- design by: **BIG - Bjarke Ingels Group**

## DIMENSIONS

- Length: **650 mm**
- Height: **650 mm**

# Alphabet of Light - Lowercase - Letter z

BIG - Bjarke Ingels Group

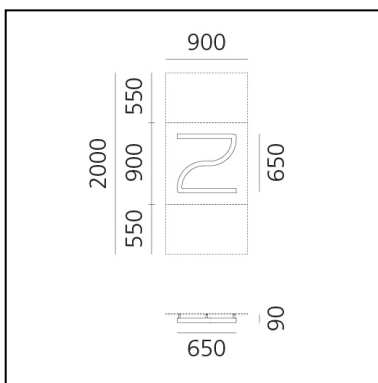
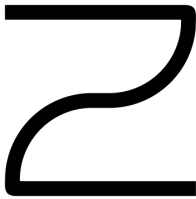

## LUMINAIRE

- Watt: **28W**
- Delivered lumen output: **2412lm**
- CCT: **3000K**
- Efficiency: **88%**
- Efficacy: **86.15lm/W**
- CRI: **80**

## Accessories

NO  
IMAGE  
AVAILABLE

Alphabet of Light -  
Lowercase - Support  
Letter z 1212z00A

## DESCRIPTION

Alphabet of light is a language based on light intended to convey freedom, an elementary principle generating an open system. BIG starts from an abacus of essential geometries to design a new font that translates into light, an alphabet used to write and to express one's thoughts, a tool to give shape to spaces. It allows to design light in space with words, as well as with graphic signs. Two linear elements of different lengths and two round ones are combined with a system of letters, numbers, and symbols. The round elements, available in two diameters, can be separated into modules to join the linear elements together according to different angles, thus designing everchanging geometries. These simple base modules, with specific geometric proportions, can be combined with each other to create countless basic or more complex, linear or curved structures of light, thus producing suspension appliances matching with architectures or space functions. The idea of BIG joins the optoelectronic competence of Artemide to define an innovative construction principle and provide continuous and comfortable lighting. While it has a minimal presence, it encloses groundbreaking patented optoelectronic and mechanical innovation.

## FEATURES

- Product Code: **1202z00A**
- Colour: **White**
- Installation: **Wall**
- Material: **Aluminum support, frosted technopolymer diffuser element.**
- Series: **Design Collection**
- Environment: **Indoor**
- Emission: **Direct/indirect**
- design by: **BIG - Bjarke Ingels Group**

## DIMENSIONS

- Length: **650 mm**
- Height: **650 mm**