

Elara,  
Design by Nika Zupanc

## Model Elara medium

The name *Elara* connotes astronomy and Greek mythology, and its geometric design mimicks the trajectory of the planets within the universe. Inspired by astral motion, the lamp is characterised by two metal rings, one of which can be set at various angles to produce fluidity and movement, as well as a small sphere at the bottom of the lamp that contains the light source.

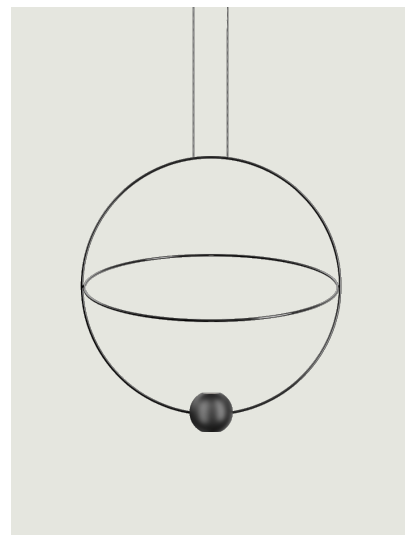

Elara medium	Light source	Structure: Metal	Code 2700 K	Code 3000 K	
	LED 2700 K 27 W Side I 2100 lm Side II 800 lm 1000 mA CRI 90 MacAdam 3-Step	Glossy Black – 9005 Polished Gold	Matte Black – 9005 Matte Gold	20621 2227 20621 5027	20621 2230 20621 5030
	LED 3000 K 27 W Side I 2260 lm Side II 845 lm 1000 mA CRI 90 MacAdam 3-Step  LED and driver included	Matte Black – 9005 Matte Gold	20621 2227 20621 5027	20621 2230 20621 5030	

Net weight: 1.90 kg
Parcels: 1
CE
IP20
Energy Saving
Dim Triac
ERC

Energy efficiency class

2700 K **D** + **E** 3000 K **D** + **F**

## Ecodesign Regulation

The LED-only light source contained in this fixture must only be replaced by the manufacturer, its support service or similarly qualified personnel.

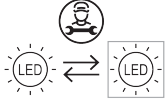

The LED driver contained in this fixture must only be replaced by the manufacturer, its support service or similarly qualified personnel.

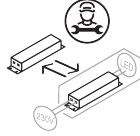

## Options of Elara

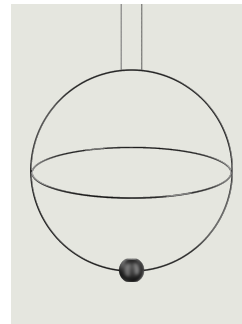

Elara large

# LODES

---

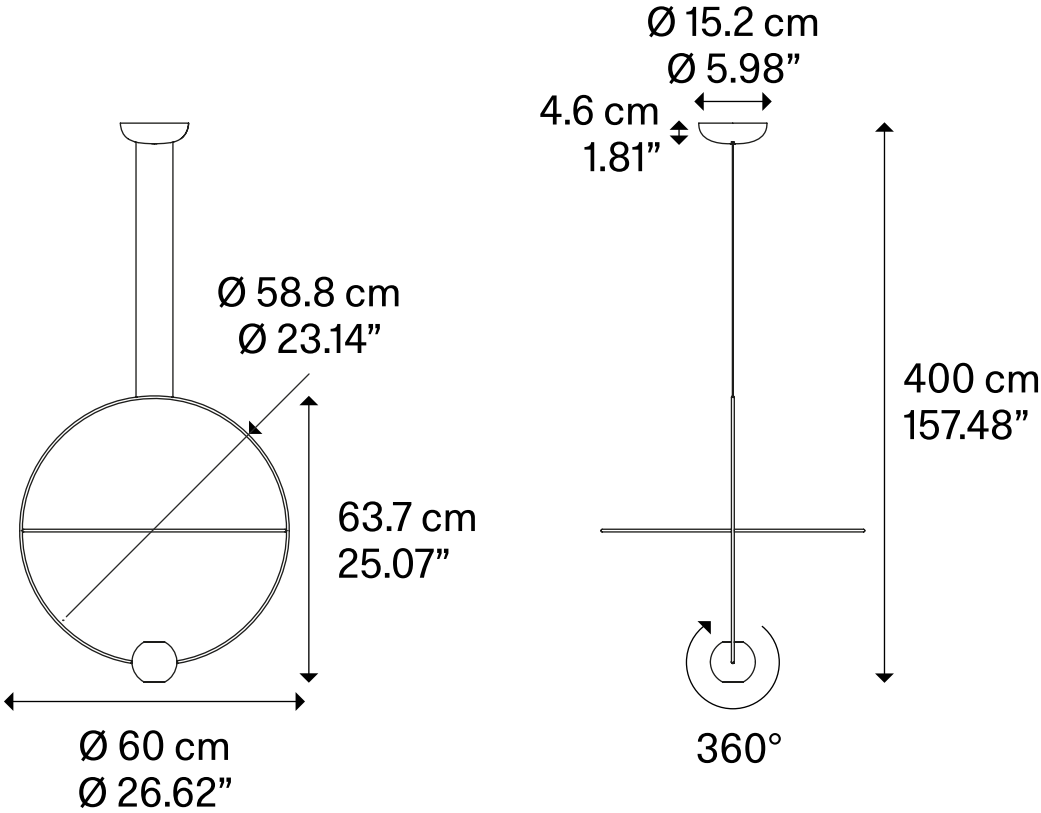

Elara,  
Design by Nika Zupanc

## Model Elara large

The name *Elara* connotes astronomy and Greek mythology, and its geometric design mimicks the trajectory of the planets within the universe. Inspired by astral motion, the lamp is characterised by two metal rings, one of which can be set at various angles to produce fluidity and movement, as well as a small sphere at the bottom of the lamp that contains the light source.

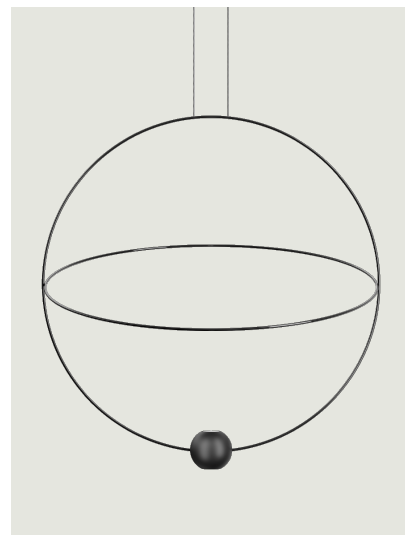

Elara large	Light source	Structure: Metal	Code 2700 K	Code 3000 K	
	LED	Glossy Black – 9005	Matte Black – 9005	20622 2227	20622 2230
	27 W	Polished Gold	Matte Gold	20622 5027	20622 5030
	Side I 2100 lm				
	Side II 800 lm				
	1000 mA				
	CRJ 90				
	MacAdam 3-Step				
	or				
	LED				
	3000 K				
	27 W				
	Side I 2260 lm				
	Side II 845 lm				
	1000 mA				
	CRI 90				
	MacAdam 3-Step				
	LED and driver included				

Net weight: 2.00 kg
Parcels: 1
CE
IP20
Energy Saving
Dim Triac
ERC

Energy efficiency class

2700 K **D** + **E** 3000 K **D** + **F**

#### Ecodesign Regulation

The LED-only light source contained in this fixture must only be replaced by the manufacturer, its support service or similarly qualified personnel.

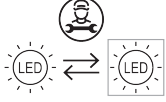

The LED driver contained in this fixture must only be replaced by the manufacturer, its support service or similarly qualified personnel.

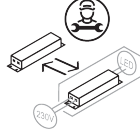

#### Options of Elara



Elara medium

# LODES

---

