

# FLOS

F1037009 White

## Bon Jour Unplugged

Designed by Philippe Starck, 2015



2.5W - 181lm - 2700K - CRI> 90

Cordless table lamp providing direct light. Painted or electroplated base and top cover in ABS. Injection moulded PMMA clear transparent diffuser and lampshade. Edge Lighting technology light source. 6/24 hours battery life, rechargeable with Micro-USB. Optical switch sensor on the base that provide 4-step dimming function. USB-C charger cable included in the package useful length 120 cm. Plug-in USB battery charger with interchangeable plugs.

Are you a professional and your project needs consulting and support?

BOOK AN APPOINTMENT

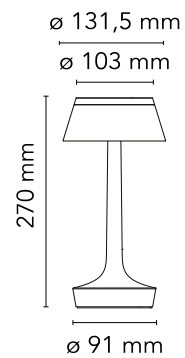

### Main specifications

EAN	8059607014509
Mounting	Table
Environments	Indoor dry location
Light Source Type	LED
LED type	LED Module
Power (W)	2.5
System flux (lm)	181

### Physical

Colour	White
Net weight (kg)	0.55
Package height (mm)	170
Package width (mm)	230
Package length (mm)	375
Package volume (m3)	0.01
IP internal	20

### Download

Mounting instructions [↓ PDF](#)  
Spare Parts [↓ PDF](#)

### Ecodesign and Energy Labelling

This product contains a light source of energy efficiency class F

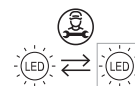

Replaceable (LED only) light source by a professional

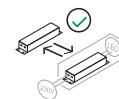

Replaceable control gear by an end-user



## Schematic light drawing

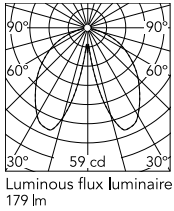

### Photometric

Lighting type	Direct
Light distribution	Roto symmetric
CCT (K)	2700
CRI>	90

### Electrical

Insulation class	III
Frequency (Hz)	50/60
Main voltage (Vac)	100-240/5
Driver	Remote included
Dimmable	Yes
Dimming type	Electronic 5V
Dimming interface	Dimmer Integrated
Plug type	Type G, Type A, Type C
Batteries inside	Yes
Battery type	LI-PO
Charging max power	14
Charging min time	3h - 0% to 100%
Charging socket/connector	USB-C

## Accessories & Power Supply



OPTIONAL

F1036000

Bon Jour Unplugged Crown



OPTIONAL

F1036007

Bon Jour Unplugged Crown



OPTIONAL

F1036019

Bon Jour Unplugged Crown



OPTIONAL

F1036030

Bon Jour Unplugged Crown



OPTIONAL

F1036035

Bon Jour Unplugged Crown

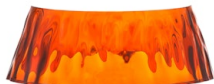

OPTIONAL

F1036070

Bon Jour Unplugged Crown

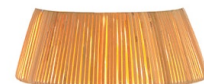

OPTIONAL

F1036088

Bon Jour Unplugged Crown

## Spare Parts

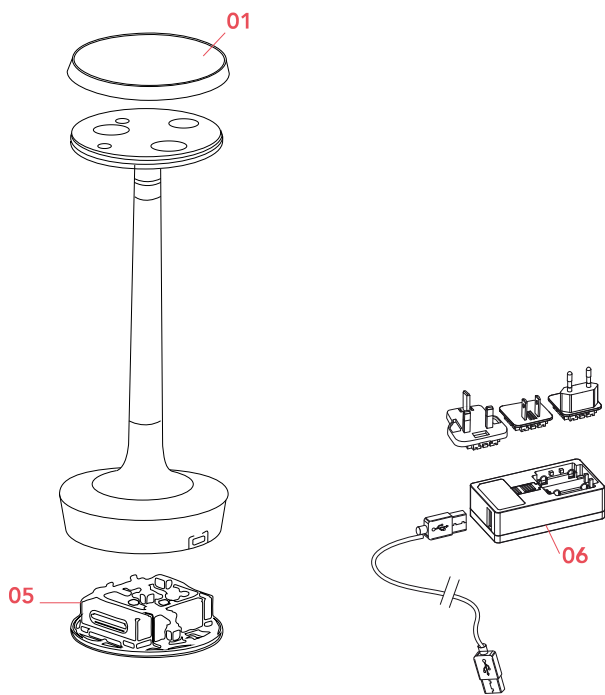

- |     |   |           |
|-----|---|-----------|
| 01. | Top cover white assembly                    | RF25453   |
| 05. | Base assembly with new battery kit          | RF1037200 |
| 06. | Power charger with electrical cable & plugs | RF1035109 |

**DOWNLOAD**



RF25453

Top cover white assembly

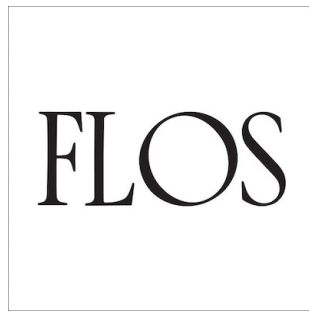

RF1037200

Base assembly with new battery  
kit



RF1035109

Power charger with electrical  
cable & plugs