

# FLOS

 F1070075 Brick Red

## Bellhop Floor

Designed by Edward Barber and Jay Osgerby, 2020

26W - 1023lm - 2700K - CRI> 90



Floor lamp with indirect light. Stem in painted aluminium: shiny white, brick, cioko, green. Reflector in shiny opal white and grey blown glass. Electrical cable of 270 cm usable length with foot dimmer switch for ON/OFF function and brightness adjustment 10–100%. Power supply with interchangeable plugs.

Are you a professional and your project needs consulting and support?

[BOOK AN APPOINTMENT](#)

### Main specifications



EAN	8059607039717
Mounting	Floor
Environments	Indoor dry location
Light Source Type	LED
LED type	LED array
Power (W)	26
System power (W)	26
System flux (lm)	1023

### Physical

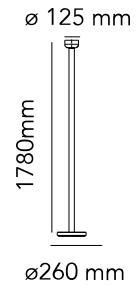
Colour	Brick Red
Length (mm)	260
Cord length (mm)	2700
Net weight (kg)	9.82
Package volume (m3)	0.05
IP internal	20



### Download

- [Mounting instructions](#)  PDF
- [Mounting instructions](#)  PDF
- [Spare Parts](#)  PDF

### Photometric Files

- [LDT / IES](#)  LDT

### Technical Drawings

- [3D](#)  ZIP
- [Bim](#)  ZIP



## Schematic light drawing

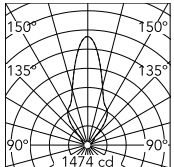

Beam Angle: 33°

h(m)	E(lx)	D(m)
1	1474	0.59
2	368	1.19
3	164	1.78
4	92	2.38
5	59	2.97

Luminous flux Luminaire  
1232 lm

## Photometric

Lighting type	Indirect
Light distribution	Roto symmetric
CCT (K)	2700
CRI>	90

## Electrical

Insulation class	III
Frequency (Hz)	50/60
Main voltage (Vac)	100-240/48
LED voltage Vf (Vdc)	null
LED current (mA)	700
Driver	Remote included
Dimmable	Yes
Dimming type	Electronic 48V
Dimming interface	Switch Integrated (Remote Dimmable)
Plug type	Type G, Type A, Type C
Batteries inside	No

## Ecodesign and Energy Labelling

This product contains a light source of energy efficiency class **G**



Replaceable (LED only)  
light source by a  
professional

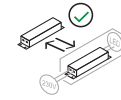

Replaceable control  
gear by an end-user

## Spare Parts

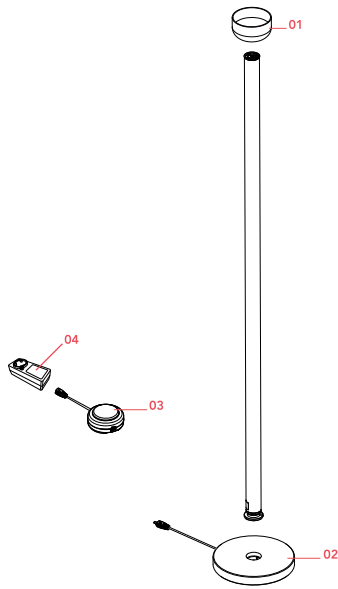

04. Black plug assembly kit & 48V driver

RF3320400

**DOWNLOAD**



RF3320400

Black plug assembly kit & 48V  
driver