

## ANVERS SMALL CEILING / WALL MOUNTED

With its refined silhouette, Anvers collection creates a maximum impact through its exquisite disc of natural alabaster stone encased within solid brass, creating a pure and elegant piece.

### FINISH

all satin brass  
ANVCWSSBHA

all bronze  
ANVCWSBZHA

### BULBS

integrated LED - trailing edge dimmable - 10.5w

3000k modified to 2700k

LED driver to be installed in the cavity

driver can be placed up to 2m away from the ceiling plate

### WEIGHT

2.5kg (5.3lbs)

### CERTIFICATION



48mm (1.9)

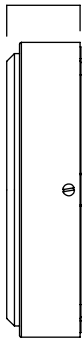

195mm (7.7)

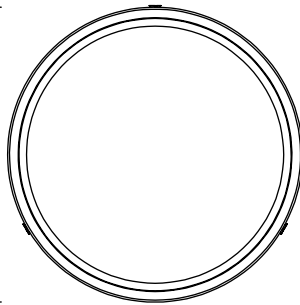

mounting plate dimensions

189mm (7.5)

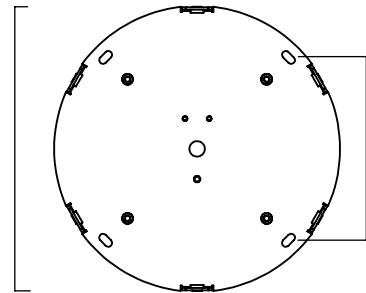

171mm (6.7)

88mm (3.5)

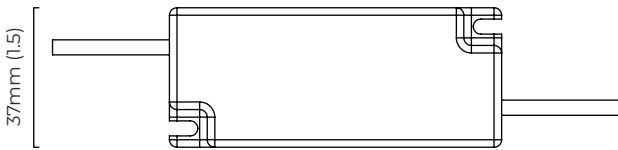

	Input Voltage	As Standard	On Request
Phase Cut (rotary dimmer)	230	✓	
0/1-10V230	230		✓
DALi	230		✓
Phase Cut (rotary dimmer)	120	✓	
0/1-10V120	120		✓
DALi	120	x	x

## ANVERS SMALL WITH WALL / CEILING ROSE

With its refined silhouette, Anvers collection creates a maximum impact through its exquisite disc of natural alabaster stone encased within solid brass, creating a pure and elegant piece.

### ADDITIONAL INFORMATION ON CEILING / WALL ROSE OPTION

#### FINISH

satin brass  
ACCGENCWOSSB

bronze  
ACCGENCWOSBZ

#### WEIGHT

3kg (6.6lbs) - Total

Note - LED driver inside ceiling / wall rose.

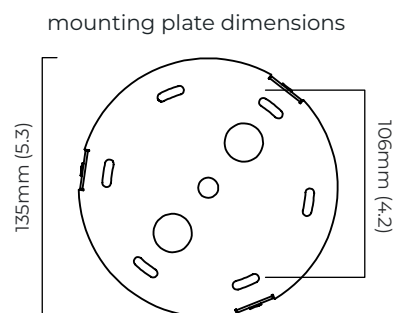
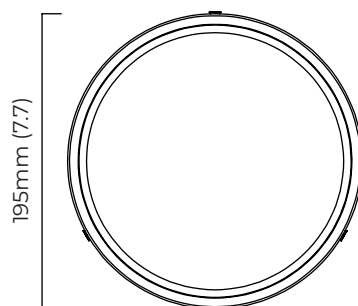
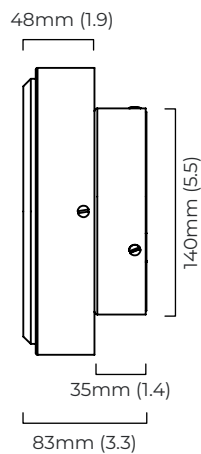

## ANVERS MEDIUM CEILING / WALL MOUNTED

With its refined silhouette, Anvers collection creates a maximum impact through its exquisite disc of natural alabaster stone encased within solid brass, creating a pure and elegant piece.

### FINISH

all satin brass  
ANVCWMSBHA

all bronze  
ANVCWMBZHA

### BULBS

integrated LED - trailing edge dimmable - 17w

3000k modified to 2700k

LED driver to be installed in the cavity

driver can be placed up to 2m away from the ceiling plate

### WEIGHT

7kg (15.5lbs)

### CERTIFICATION



48mm (1.9)

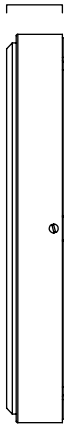

335mm (13.2)

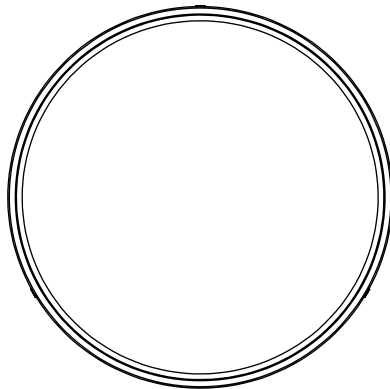

mounting plate dimensions

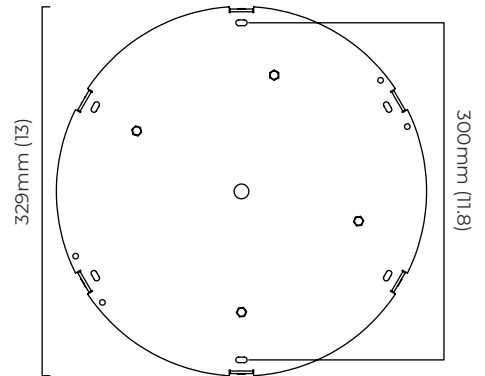

112mm (4.4)

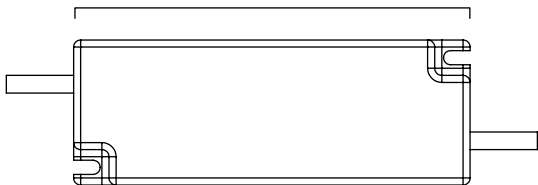

41mm (1.6)

25mm (1)



	Input Voltage	As Standard	On Request
Phase Cut (rotary dimmer)	230	✓	
0/1-10V230	230		✓
DALi	230		✓
Phase Cut (rotary dimmer)	120	✓	
0/1-10V120	120		✓
DALi	120	x	x

## ANVERS MEDIUM WITH WALL / CEILING ROSE

With its refined silhouette, Anvers collection creates a maximum impact through its exquisite disc of natural alabaster stone encased within solid brass, creating a pure and elegant piece.

### ADDITIONAL INFORMATION ON CEILING / WALL ROSE OPTION

#### FINISH

all satin brass (wall rose only)  
ACCGENCWOMSB

all bronze (wall rose only)  
ACCGENCWOMBZ

#### WEIGHT

9kg (20lbs) - Total

Note - LED driver inside ceiling / wall rose.

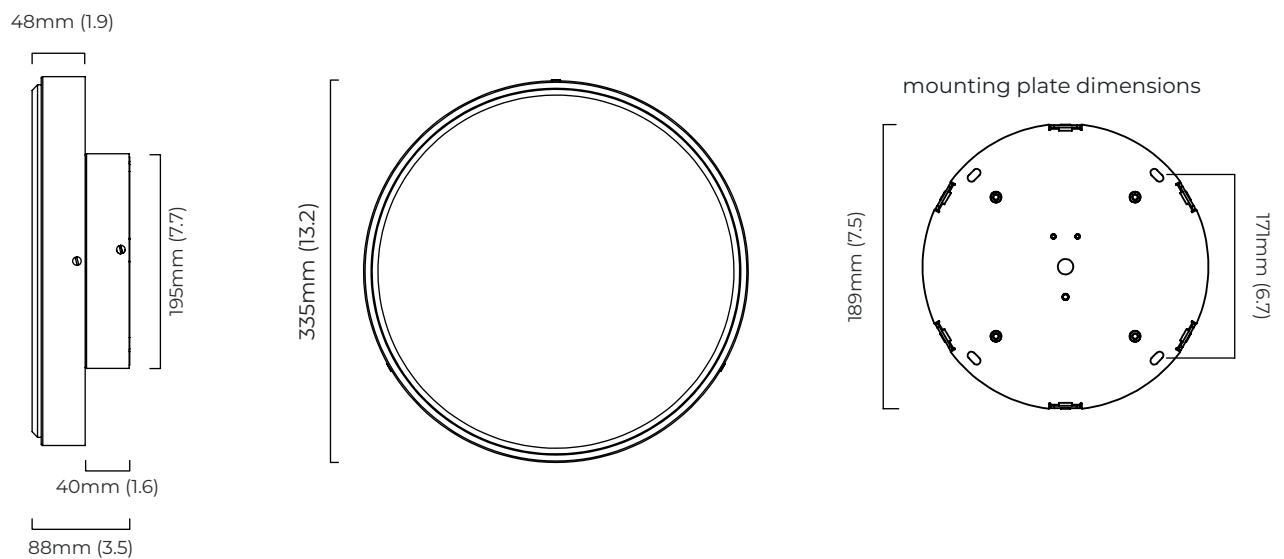

## ANVERS LARGE CEILING / WALL MOUNTED

With its refined silhouette, Anvers collection creates a maximum impact through its exquisite disc of natural alabaster stone encased within solid brass, creating a pure and elegant piece.

### FINISH

all satin brass  
ANVCWLSBHA

all bronze  
ANVCWLBZHA

### BULBS

integrated LED - trailing edge dimmable - 24w

3000k modified to 2700k

LED driver to be installed in the cavity

driver can be placed up to 2m away from the ceiling plate

### WEIGHT

20kg (40lbs)

### CERTIFICATION



48mm (1.9)

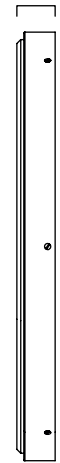

545mm (21.5)

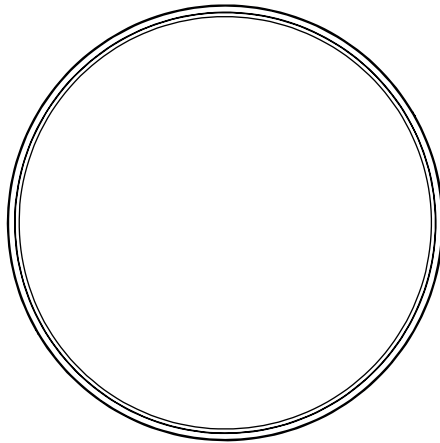

112mm (4.4)

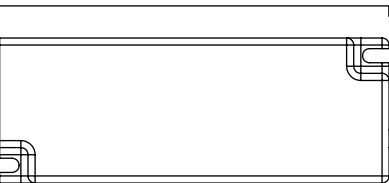

41mm (1.6)



25mm (1)

mounting plate dimensions

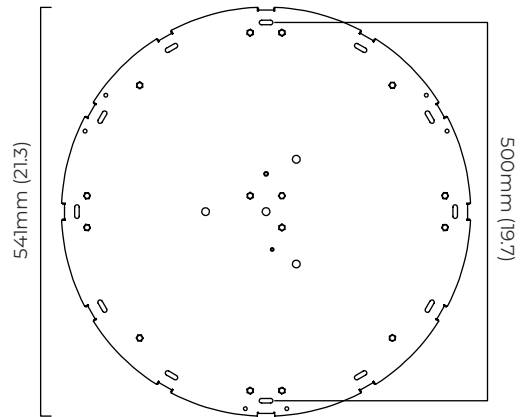

541mm (21.3)

500mm (19.7)

	Input Voltage	As Standard	On Request
Phase Cut (rotary dimmer)	230	✓	
0/1-10V230	230		✓
DALi	230		✓
Phase Cut (rotary dimmer)	120	✓	
0/1-10V120	120		✓
DALi	120	x	x

## ANVERS LARGE WITH WALL / CEILING ROSE

With its refined silhouette, Anvers collection creates a maximum impact through its exquisite disc of natural alabaster stone encased within solid brass, creating a pure and elegant piece.

### ADDITIONAL INFORMATION ON CEILING / WALL ROSE OPTION

#### FINISH

all satin brass (wall rose only)  
ACCGENCWOLSB

all bronze (wall rose only)  
ACCGENCWOLBZ

#### WEIGHT

23kg (51lbs) - Total

Note - LED driver inside ceiling / wall rose.

