

# Artemide®

## nh1217

design  
Neri & HU

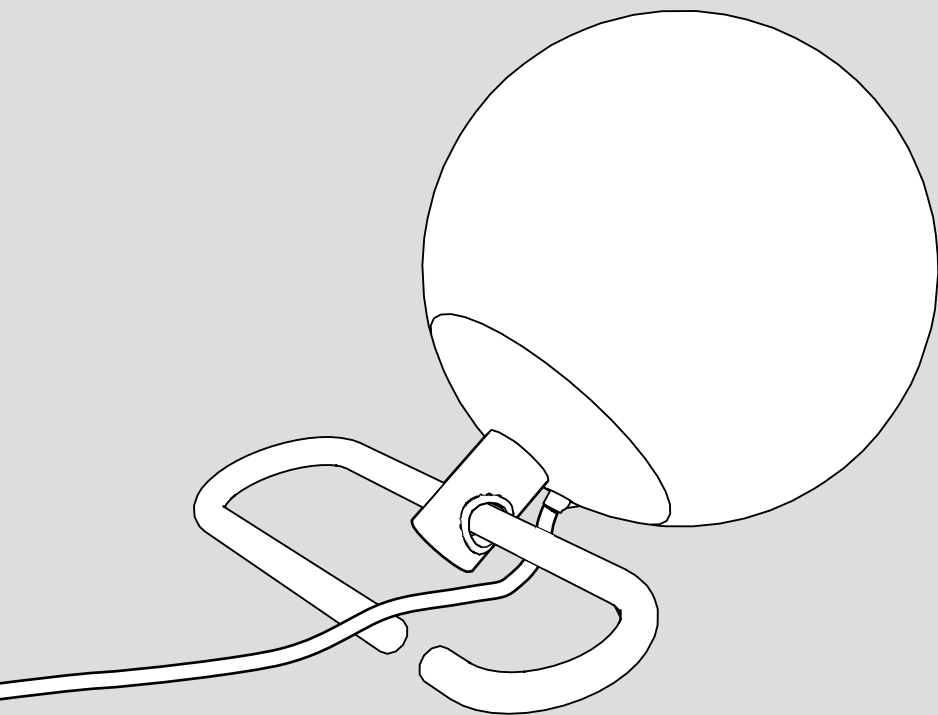



i

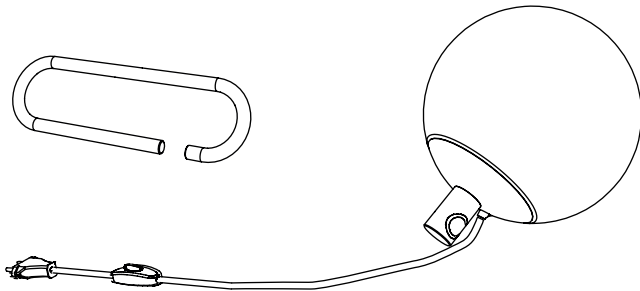
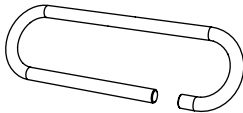
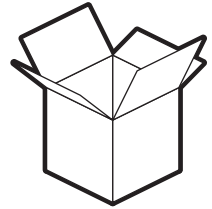
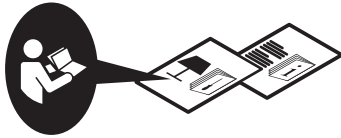
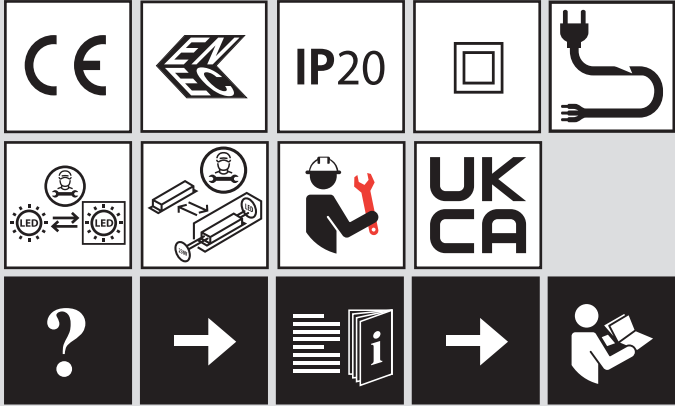

1

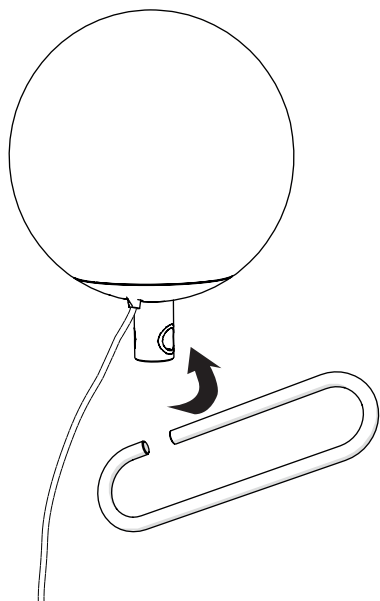

2

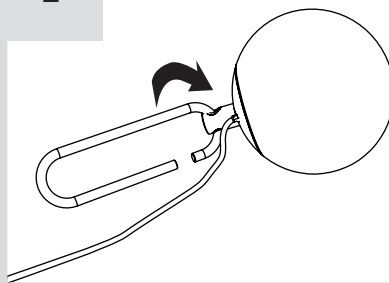

3

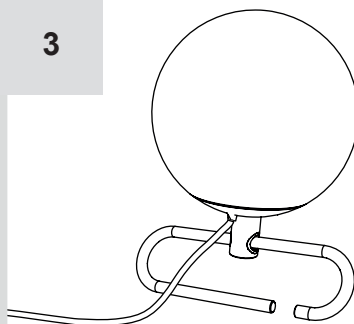

4

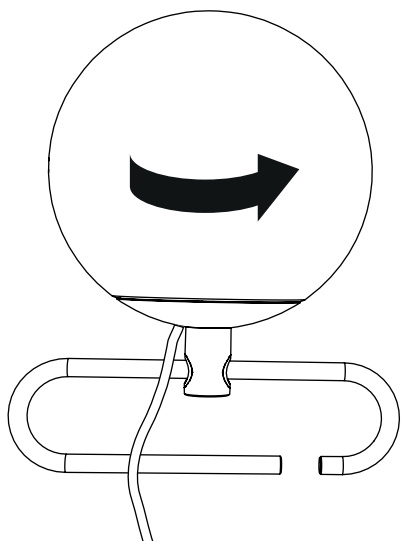

5

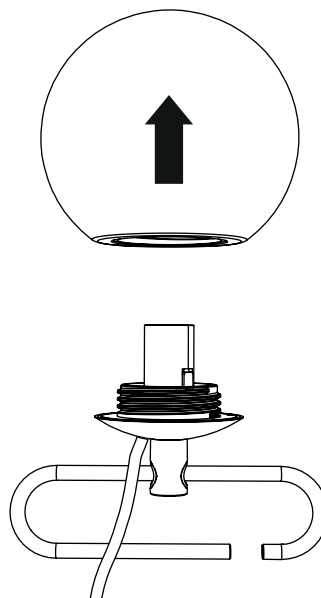

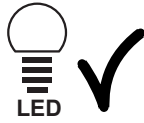

LED



HALO



HALO



FLUO

7

E14 - MAX 5W LED

max 80mm

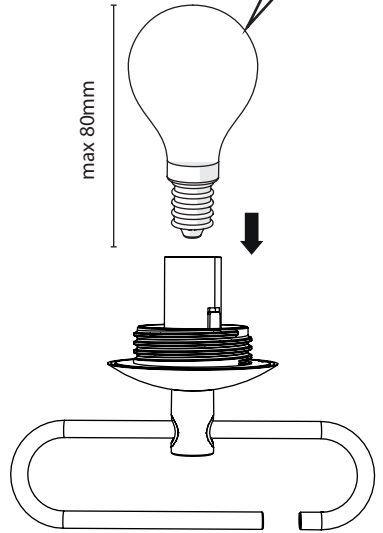

8

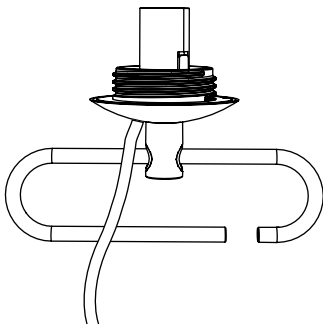
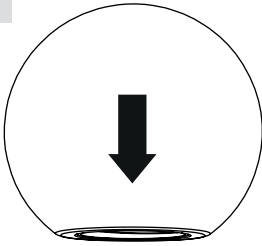

9

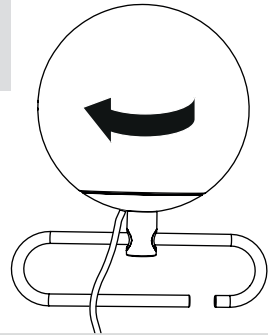

10

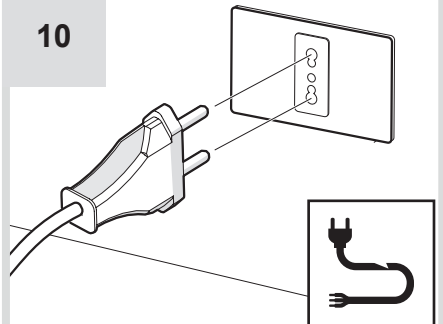

11

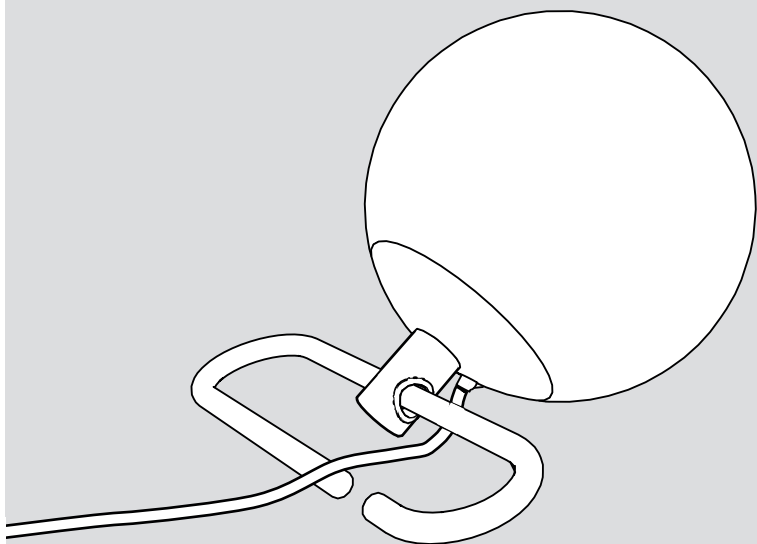
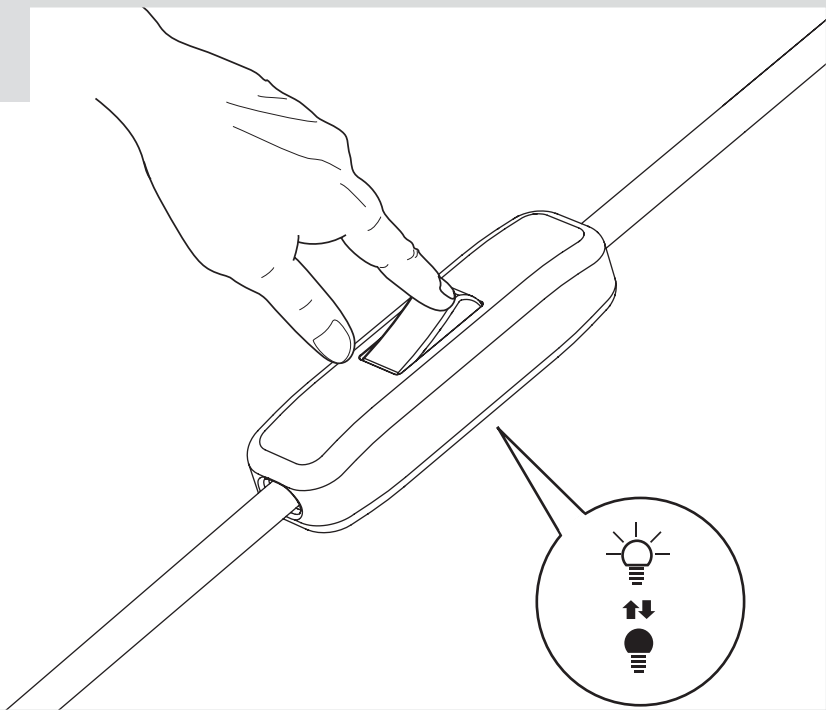

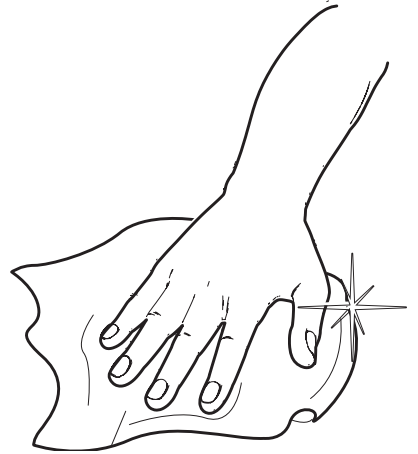
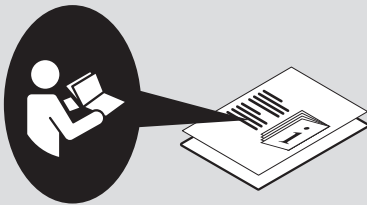
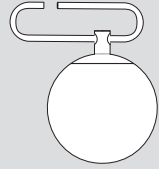
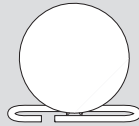
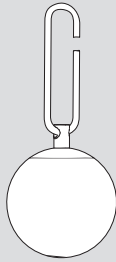
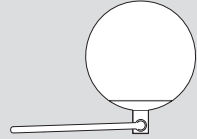
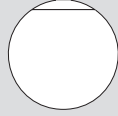
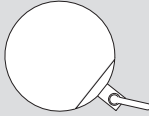
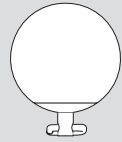
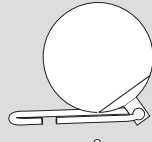
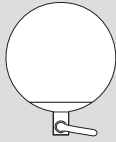



**Artemide®**



## **Artemide**

via Bergamo, 18  
20010 Pregnana M.se (MI)  
ITALIA

tel. +39 02 935 181  
fax +39 02 935 90 254  
fax +39 02 935 90 496

[www.artemide.com](http://www.artemide.com)

VAT IT00846890150

cod. Y513000860A