

## Cirio Chandelier

Antoni Arola. 2015  
Pendant lamps



Porcelain



Glass



Brass

Chandelier S

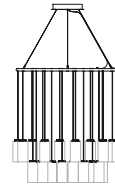

A

Chandelier M

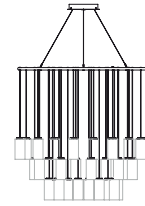

B

Chandelier L



C



The Cirio Chandelier pools a large body of light onto a focal axis that stands out hugely from its surrounding area. Its dense array of concentric rings, from which twenty, thirty and even forty light sources may be hung thanks to the enlargeable diameter of the structure, gives off a warm, powerful light with a major visual impact.

The shade, beautifully designed, is reminiscent of a candle for its shape, texture and the warmth of its light. The varying shades combined with LED capsules can be used to create different atmospheres: from the porcelain of Sargadelos (Galicia, Spain) that creates candle-like warmth, to translucent opal glass, and the opaque elegance of brass.

Cirio is a system that provides customisable solutions for vertical lighting by combining structures, shades and light textures. The pendant lamp can be used alone or arranged in rows or clusters to illuminate larger areas, in forms such as the Chandelier, Cascada, Circular, Linear, Oval or Múltiple. A perfect combination of repeated elements. The fusion of technology and tradition; innovation through craftsmanship. A truly unique lighting experience.

### General description:

Capsule with LED module, translucent white diffuser and heat sink with black matte finish.

3 lampshade options: white porcelain, white opal glass and polished brass.

Black aluminium circular structure:

(A) ø 100 cm / 39.4" for 20 lampshades

(B) ø 130cm / 51.2" for 30 lampshades

(C) ø 160 cm / 63" for 40 lampshades

Adjustable black metallic circular canopy + equipment.

2 hanging system options: direct cable to ceiling plate or direct cable to ceiling.

Suitable for Junction Box (UL market).

Electric cable length: 5 m / 196.8"

### Approximate weight (unpacked):

(A) Chandelier S: 20 Kg / 44 lb

(B) Chandelier M: 30 Kg / 66 lb

(C) Chandelier L: 40 Kg / 88 lb

Lampshades:

Porcelain: 0,5 kg / 1.1 lb

Glass: 0,6 kg / 1.3 lb

Brass: 0,3 Kg / 0.7 lb

## Cirio Chandelier

Antoni Arola. 2015  
Pendant lamps

### Technical information:

Light source included (dimmable):  
LED module

Rated input wattage (LED capsule): 5,7 W  
Operating current: 530 mA  
Colour Temp.: 2.700 K  
CRI: 90  
Lifetime: 40.000 h

(A) 20 light sources  
Rated input wattage: 114 W  
Luminous flux:  
Porcelain 3.280 lm  
Glass 11.180 lm  
Brass 3.520 lm

(B) 30 light sources  
Rated input wattage: 171 W  
Luminous flux:  
Porcelain 4.920 lm  
Glass 16.770 lm  
Brass 5.280 lm

(C) 40 light sources  
Rated input wattage: 228 W  
Luminous flux:  
Porcelain 6.560 lm  
Glass 22.360 lm  
Brass 7.040 lm

Built-in adjustable LED.  
Lamp suitable for dimming 1-10V. / DALI. Not included external dimmer switch 1-10V. / DALI  
Energy efficiency class (E.E.C): A++...A.  
Lamp suitable only for indoor use.

Input voltage: 120 ~ 277 Vac.  
(50 Hz / 60 Hz). According to destination.

### White porcelain lampshade

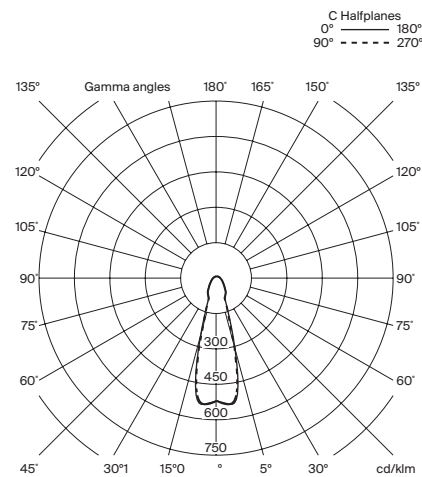

### White opal glass lampshade

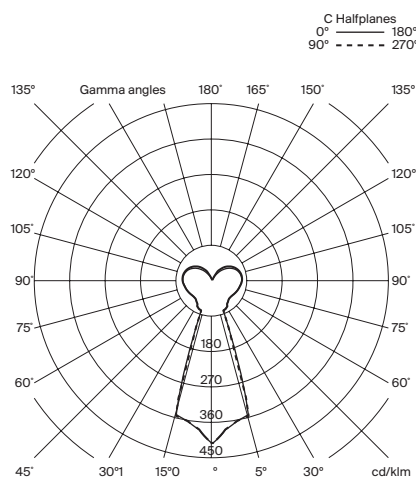

### Brass lampshade

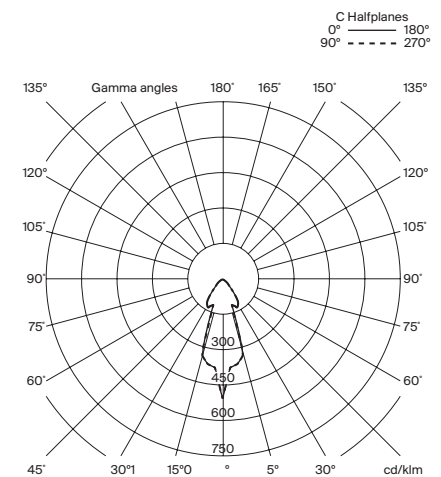

### Regulations:

CE  
UNE-EN 60598  
UNE-EN 55015  
UNE-EN 62031  
UNE-EN 61000-3-2  
UNE-EN 60529  
UNE-EN 61347-2-13

UL  
Dry and damp location  
UL-1598  
UL-8750  
E-336377

### Maintenance:

Clean with a smooth cloth. Do not use ammonia, solvents or abrasive cleaning products.

### Others:

The lamp is delivered in different packages.  
The assembly instructions are delivered with the product.

# Cirio Chandelier

Antoni Arola. 2015  
Pendant lamps

## Model: Lampshades

White porcelain

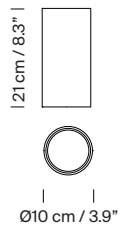

White opal glass

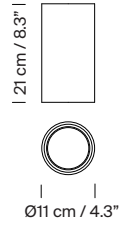

Brass

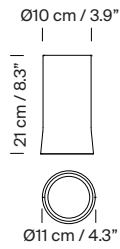

## Model A: Cirio Chandelier S

Direct cable to canopy

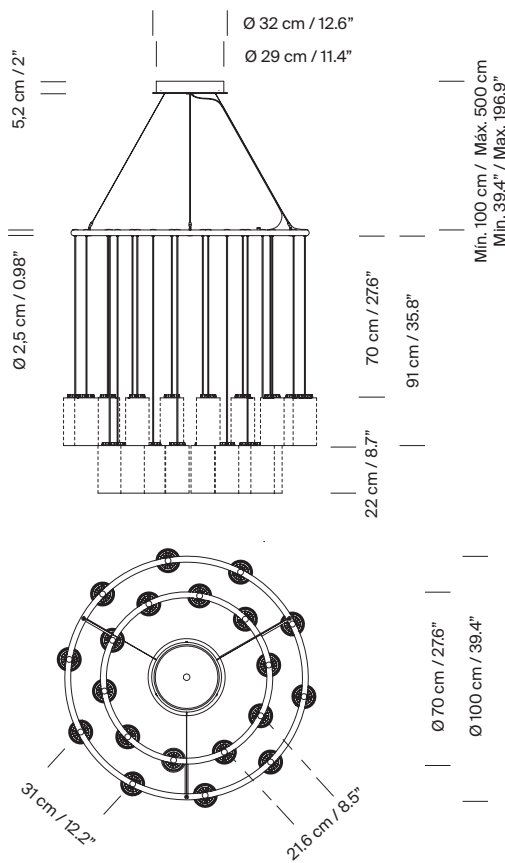

Direct cable to ceiling

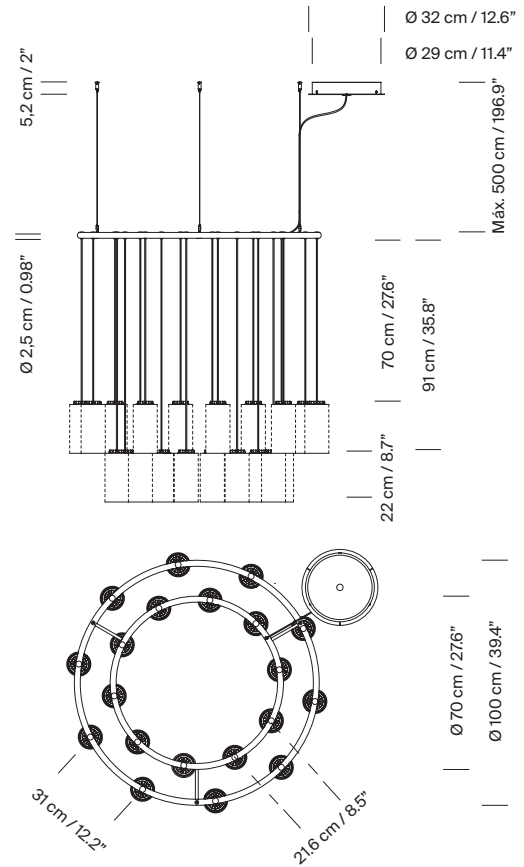

# Cirio Chandelier

Antoni Arola. 2015

Pendant lamps



SANTA & COLE

## Model B: Cirio Chandelier M

Direct cable to canopy

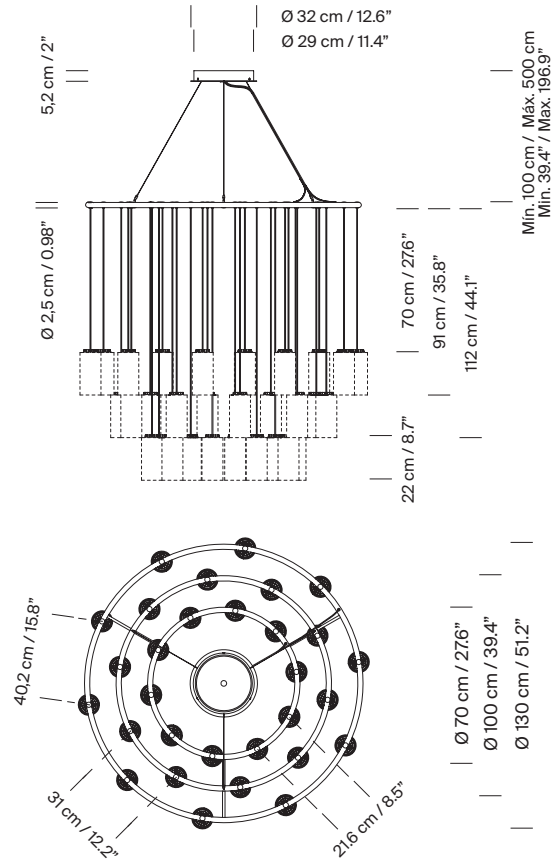

Direct cable to ceiling

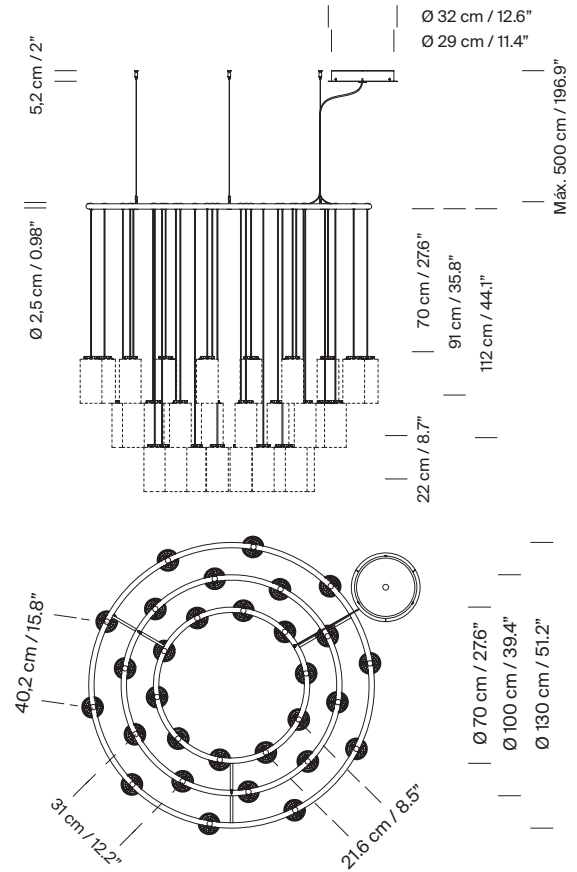

# Cirio Chandelier

Antoni Arola. 2015  
Pendant lamps

## Model C: Cirio Chandelier L

Direct cable to canopy

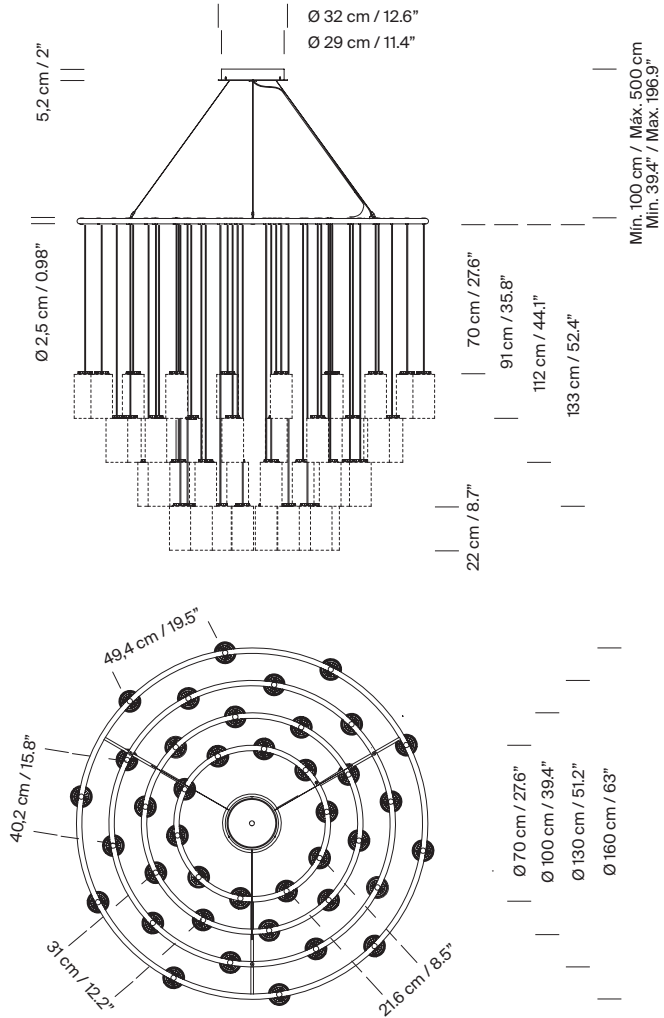

# Cirio Chandelier

Antoni Arola. 2015  
Pendant lamps

## Model C: Cirio Chandelier L

Direct cable to ceiling

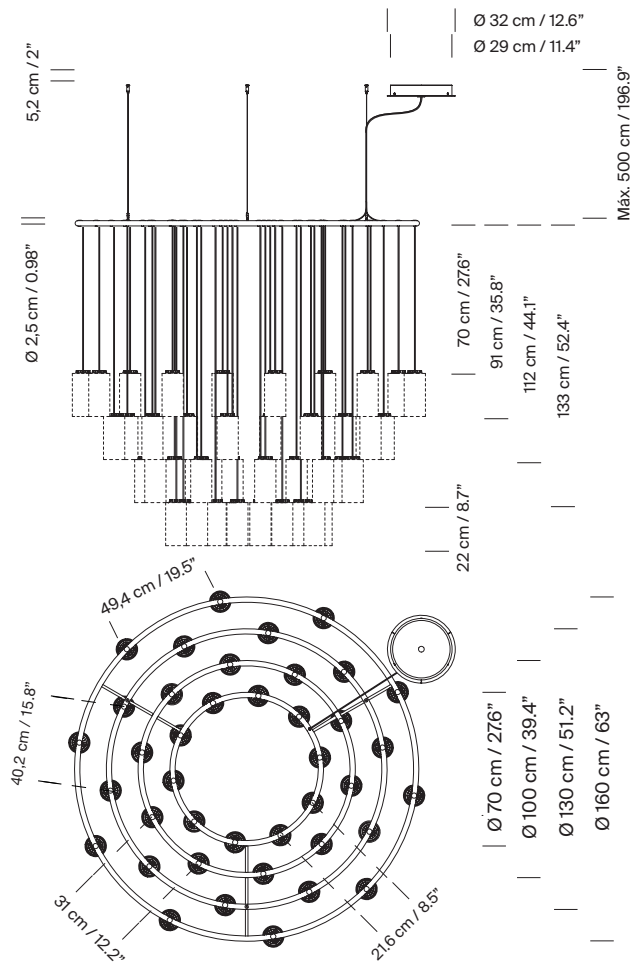

## Collection:

Pendant lamps



Cirio Simple



Cirio Múltiple



Cirio Cascada



Cirio Circular



Cirio Lineal



Cirio Chandelier

## Wall lamps



Cirio