

## Cirio Cascada

Antoni Arola. 2017  
Pendant lamps



Porcelana



Vidrio



Latón

5 Circular



A

7 Circular

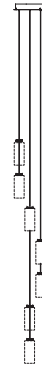

B

9 Circular

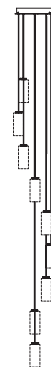

C

12 Rectangular

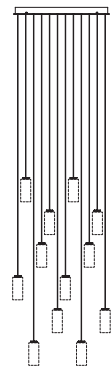

D



Cirio Cascada features a compact, ornamental design. This shimmering cascade of light lends a warm atmosphere to large spaces; ideal for staircases and high ceilings of different heights.

The shade, beautifully designed, is reminiscent of a candle for its shape, texture and the warmth of its light. The varying shades combined with LED capsules can be used to create different atmospheres: from the porcelain of Sargadelos (Galicia, Spain) that creates candle-like warmth, to translucent opal glass, and the opaque elegance of brass.

Cirio is a system that provides customisable solutions for vertical lighting by combining structures, shades and light textures. The pendant lamp can be used alone or arranged in rows or clusters to illuminate larger areas, in forms such as the Chandelier, Cascada, Circular, Lineal, Oval or Múltiple. A perfect combination of repeated elements. The fusion of technology and tradition; innovation through craftsmanship. A truly unique lighting experience.

### General description:

Capsule with LED module, translucent white diffuser and heat sink with black matte finish.

3 lampshade options: white porcelain, white opal glass and polished brass.

Black metal canopies family (3 circular options and 1 rectangular) with integrated equipment:

(A) Ø32 cm / 12.6" for 5 lampshades.

(B) Ø32 cm / 12.6" for 7 lampshades.

(C) Ø40 cm / 15.8" for 9 lampshades.

(D) 96 cm x 32 cm / 37.8" x 12.6" for 12 lampshades.

Suitable for Junction Box (UL market).

Electric cable length: 3 m / 118.1" - 8 m / 315"

### Approximate weight (unpacked):

(A) 5 Circular\*:

3 m: 7 Kg / 15.5 lb

8 m: 8 Kg / 17.6 lb

(B) 7 Circular\*:

3 m: 9 Kg / 19.8 lb

8 m: 10 Kg / 22 lb

(C) 9 Circular\*:

3 m: 12 Kg / 26.5 lb

8 m: 14 Kg / 30.9 lb

(D) 12 Rectangular\*:

3 m: 18 Kg / 39.7 lb

8 m: 20 Kg / 44 lb

Lampshades:

Porcelain: 0,5 kg / 1.1 lb

Glass: 0,6 kg / 1.3 lb

Brass: 0,3 Kg / 0.7 lb

\*With porcelain lampshade

## Cirio Cascada

Antoni Arola. 2017  
Pendant lamps

### Technical information:

Light source included:  
LED module

Rated input wattage (LED capsule): 7,7 W  
Operating current: 700 mA  
Colour Temp.: 2.700 K  
CRI: 90  
Lifetime: 40.000 h

(A)  
Rated input wattage: 46,1 W  
Luminous flux:  
Porcelain 1.110 lm  
Glass 3.275 lm  
Brass 1.185 lm

(B)  
Rated input wattage: 64,6 W  
Luminous flux:  
Porcelain 1.554 lm  
Glass 4.585 lm  
Brass 1.659 lm

(C)  
Rated input wattage: 83 W  
Luminous flux:  
Porcelain 1.998 lm  
Glass 5.895 lm  
Brass 2.133 lm

(D)  
Rated input wattage: 110 W  
Luminous flux:  
Porcelain 2.664 lm  
Glass 7.860 lm  
Brass 2.844 lm

Built-in LED.  
Suitable for dimming 1-10V. (Not included external dimmer switch 1-10V).  
Energy efficiency class (E.E.C): A++...A.  
Suitable only for indoor use.

Input voltage: 120 ~ 277 Vac.  
(50 Hz / 60 Hz). According to destination.

### White porcelain lampshade

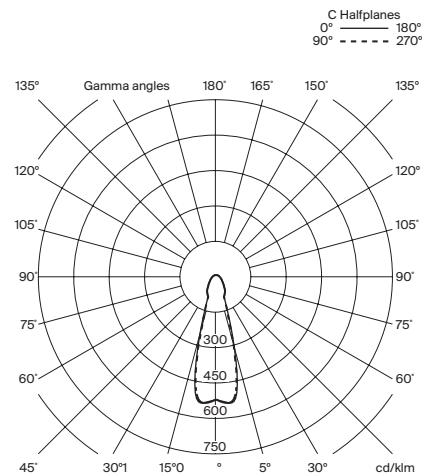

### White opal glass lampshade

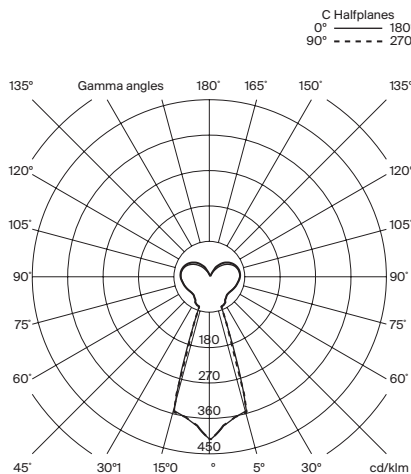

### Brass lampshade

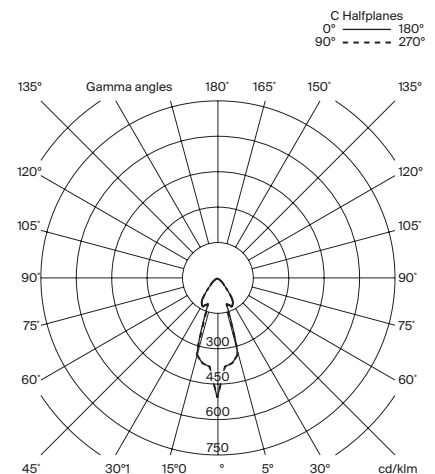

### Regulations:

CE  
UNE-EN 60598  
UNE-EN 55015  
UNE-EN 62031  
UNE-EN 61000-3-2  
UNE-EN 60529  
UNE-EN 61347-2-13

UL  
Dry and damp location  
UL-1598  
UL-8750  
E-336377

### Maintenance:

Clean with a smooth cloth. Do not use ammonia, solvents or abrasive cleaning products.

### Others:

The lamp is delivered in different packages.  
The assembly instructions are delivered with the product.

# Cirio Cascada

Antoni Arola. 2017  
Pendant lamps

## Model: Lampshades

White porcelain

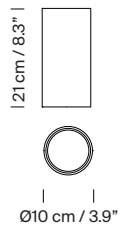

White opal glass

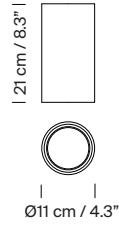

Brass

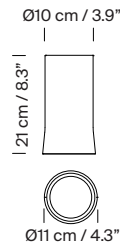

## Model A: Cirio Cascada 5

Spiral composition

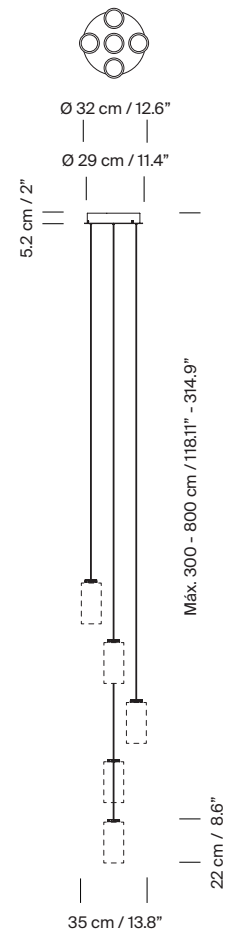

Random composition

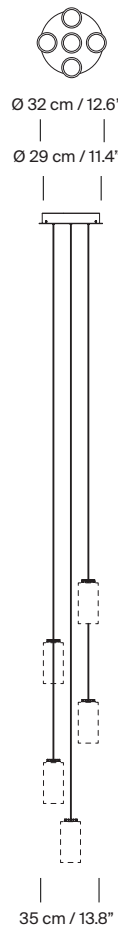

## Model B: Cirio Cascada 7

Spiral composition

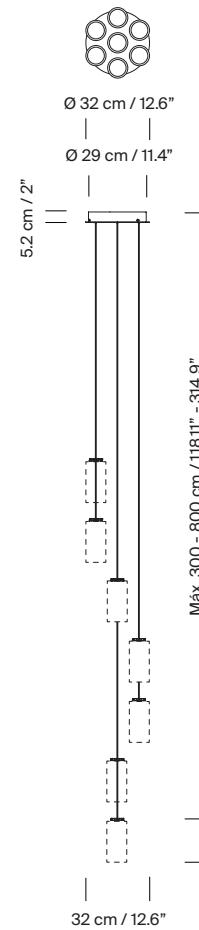

Random composition

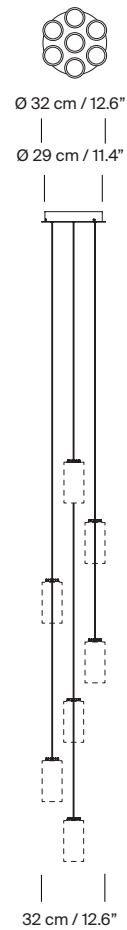

**Model C:** Cirio Cascada 9

**Model D:** Cirio Cascada 12

Spiral composition

Random composition

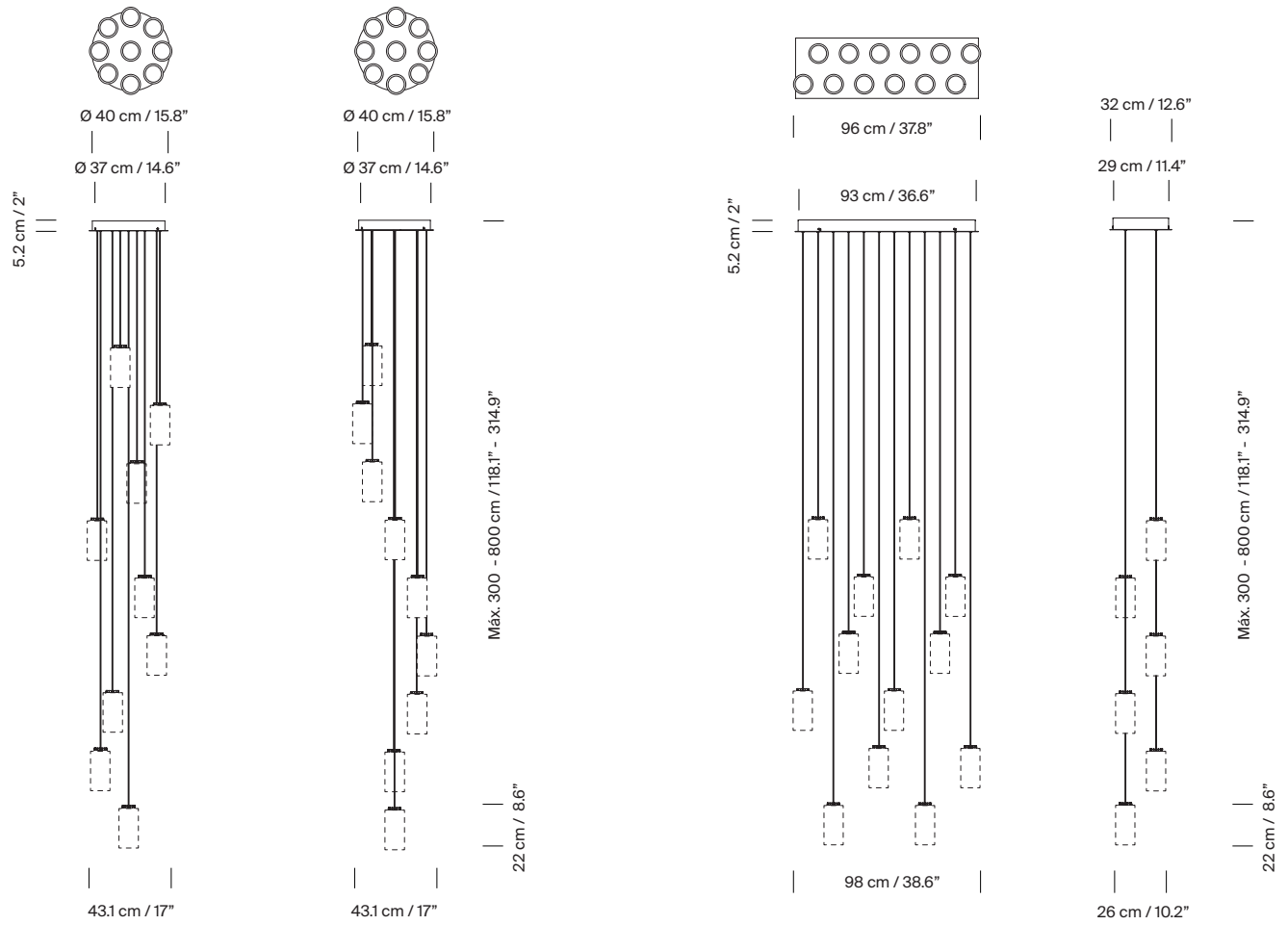

**Collection:**  
 Pendant lamps



Cirio Simple



Cirio Múltiple



Cirio Cascada



Cirio Circular



Cirio Lineal



Cirio Chandelier

Wall lamps



Cirio