

# Panthella Table

The fixture emits a glare-free, soft and comfortable illumination. The opal acrylic shade leaves a diffused comfortable light atmosphere due to the translucent shade, the downward reflection from the inner shade and the reflection from the trumpet stem.

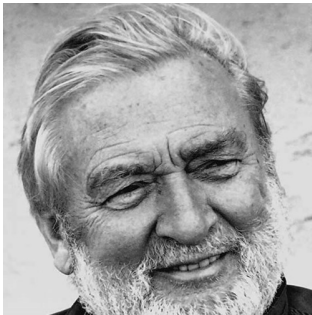

## Verner Panton

Verner Panton (1926-1998) is famous for his inspirational and colorful personality. A unique person with a special sense for color, shape, light function and space. Over the course of his career, Panton introduced a series of modern lamps with personalities unlike any of his Scandinavian contemporaries.

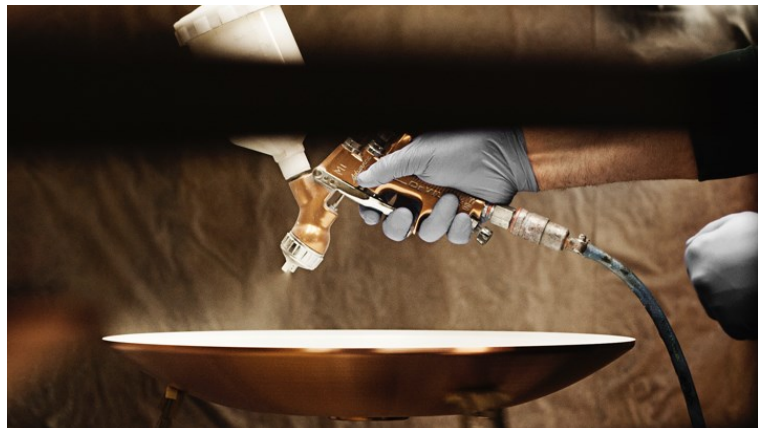

## Product info

### Mounting

Cable type: Plastic cord with plug. Cable length: 2.5m. Light control: On/off switch on cord. Diffuser with bajonet lock.

### Finish

White opal acrylic.

### Materials

Shade: Injection moulded white opal acrylic. Base: White, injection moulded ABS. Housing: White, injection moulded ABS. Stem: White, steel. Diffuser : Injection moulded opal pmma.

### Sizes and weights

Width x Height x Length (mm) | 400 x 550 x 400 Max 2.5 kg

### Class

Ingress protection IP20. Electric shock protection II w/o ground.

### Specification notes

The innovation of light sources is ongoing. Consequently we only inform about the max. wattages. On [www.louispuolsen.com](http://www.louispuolsen.com) we update a list of recommendable light sources.

### Light source

1x28W E27



## Product family



Panthella Floor



Panthella MINI

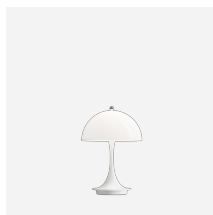

Panthella Portable

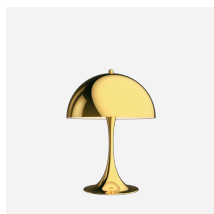

Panthella Table 320

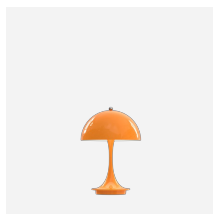

Panthella Portable Metal

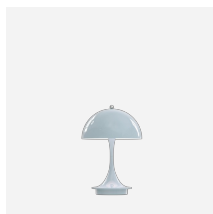

Panthella Portable V2

## Product variants

### Light source

1x28W E27

# Product description

Modern, all white, portable fixture.  
Terse and iconic design  
Matching floor version available.

---

## Mounting

Portable fixture plugs into standard wall outlet.

---

## Light description

The fixture emits glare free, comfortable light.  
Top hemispherical shade reflects light downwards

---

## Design

Verner Panton

---

## Material

Shade: opal acrylic, 1.5mm (0.06") thick.  
Base: injection molded white ABS, 1.5mm (0.06") thick.  
Switch: on/off, phenolic, on cord.  
Socket: Porcelain, medium base for A-19, frosted envelope lamps.

---

## Weight

2.519

---

## Finish

White opal acryl

# Light distribution diagrams

## Cartesian

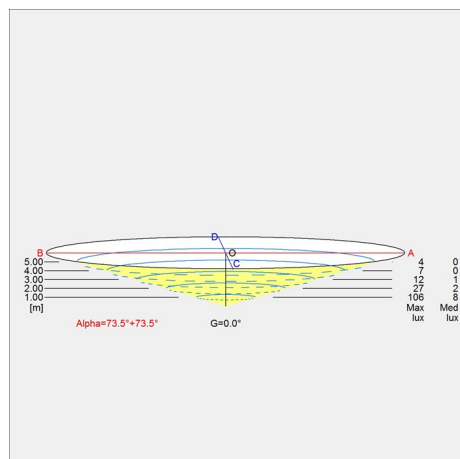

## Isolux

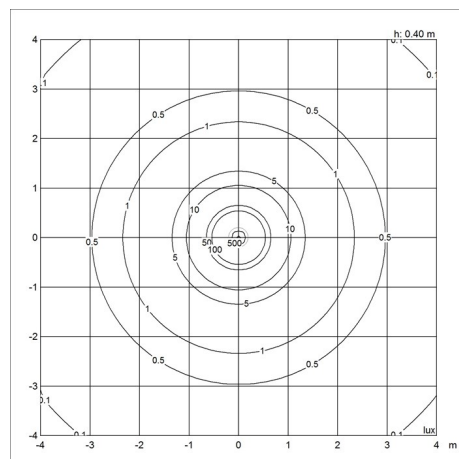

## Polar

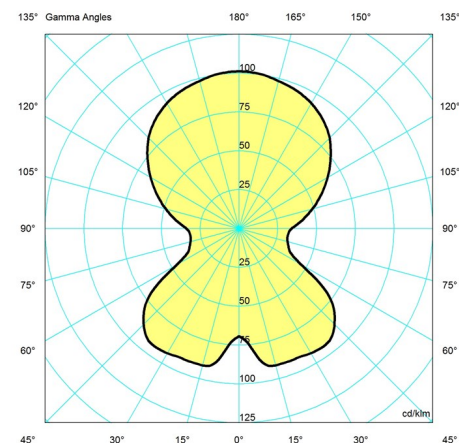

## Spare parts & accessories

### Product

Panthella Floor/Table top nut chrome  
 Panthella Table shade holder clear  
 Panthella table diffuser V2021  
 Panthella table bajonetbase V2021  
 Panthella table shade V2021

### Variant number

5744610049  
 5744610544  
 5744167479  
 5744167482  
 5744167505