

PANTHELLA 320 TABLE LAMP

The fixture emits a soft, comfortable, glare-free, light. The metal-shade versions direct the light directly downward, creating a pleasant illumination due to the inner white-painted shade and the reflection from the trumpet-shaped stem. The opal acrylic produces a diffused, comfortable light due to the translucent shade, the downward reflection from the inner shade, and the reflection from the trumpet-shaped stem.

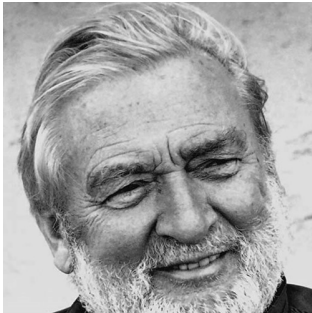

Verner Panton

Verner Panton (1926-1998) is famous for his inspirational and colorful personality. A unique person with a special sense for color, shape, light function and space. Over the course of his career, Panton introduced a series of modern lamps with personalities unlike any of his Scandinavian contemporaries.



Product info

Environmental Product Specification

This product is compliant with the requirements contained in the European Directives, RoHS Directive 2011/65 and 2015/863. This product is designed so that 100% of the product can be disassembled and reused.

Information

White cord on white opal and metallised brass versions. Black cord on grey opal and chrome versions.

Mounting

Cord type: Plastic cord with plug. Cord length: 2.5 m. Light control: On/off switch on cord. Diffuser with bajonet lock.

Finish

White opal acrylic shade with white stand. Grey opal acrylic shade with high-luster chrome stand. High-luster chrome shade and stand. Brass metallised shade and stand.

Materials

Shade: Injection-molded acrylic or deep-drawn steel. Base and housing: Cast aluminum. Diffuser: Injection-molded opal pmma.

Sizes and weights

Width x Height x Length (mm) | 320 x 438 x 320 Max 1.5 kg

Class

Ingress protection IP20. Electric shock protection II.

Light source

1x7.5W E14 Max. diameter: 48 mm Max. height: 83 mm

Information

White cord on white opal and metallised brass versions. Black cord on grey opal and chrome versions.



Related products



Panthella 400 Table Lamp



Panthella Floor

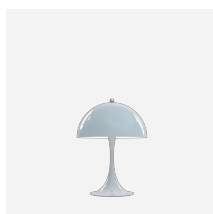

Panthella 250 Table Lamp



Panthella 160 Portable

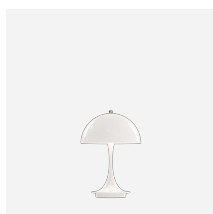

Panthella 160 Portable Metal

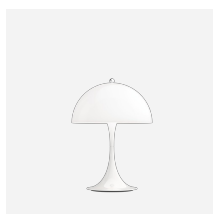

Panthella 250 Portable

Product variants

Colour	Cable type	Light source	Class
<ul style="list-style-type: none"> ● Brass metallised 	Black cord	1x7.5W E14	-
<ul style="list-style-type: none"> ● Grey opal acryl 	White cord		II
<ul style="list-style-type: none"> ● High lustre chrome plated 			
<ul style="list-style-type: none"> ● White opal acryl 			

Design

Verner Panton

Weight

Min: 1.5 kg Max: 1.5 kg

Finish

Brass metallised, Grey opal acryl, High lustre chrome plated, White opal acryl

Light distribution diagrams

Cartesian

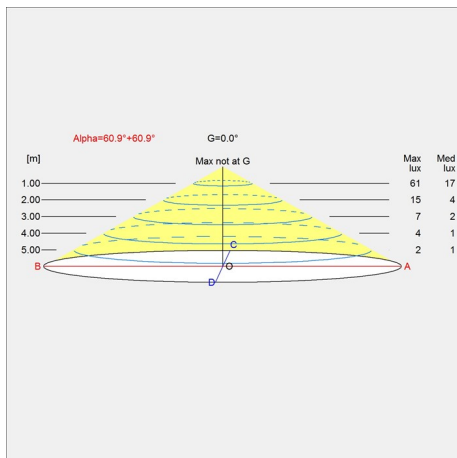

Isolux

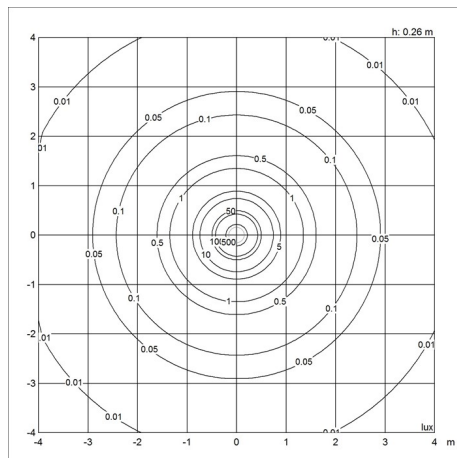

Polar

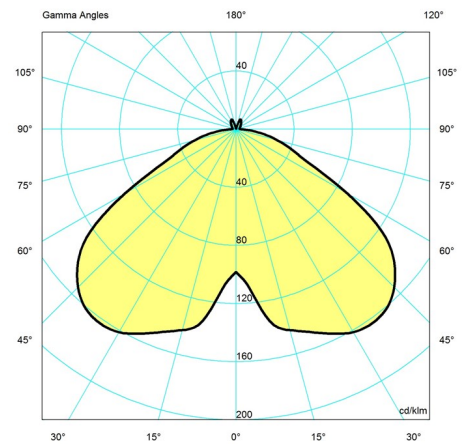

Spare parts & accessories

Panthella 320 Table Lamp

Product	Variant number
Panthella Table 320 diffuser	5744167592
Panthella Table 320 bayonet base	5744167602
Panthella 320 Opal shade	5744167615
Panthella 320 Brass shade	5744167628
Panthella 320 Chrome shade	5744167631
Panthella Table 320 top nut chrome	5744167644
Panthella Table 320 top nut brass PVD	5744167657
Panthella 320 Opal Grey shade	5744168041