

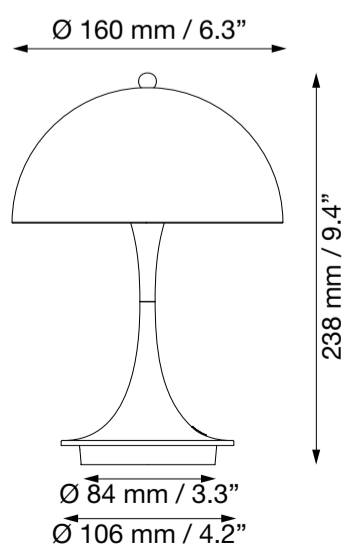

**louis poulsen**

# PANTHELLA 160 PORTABLE

DESIGNED BY  
VERNER PANTON



Lyskilde Light source Leuchtmittel Ljuskälla Sorgenti luminose Source lumineuse Fuente de luz Valonlähde ランプ	Spænding/frekvens Voltage/frequency Spannung/frequenz Spänning/frekvens Tensione/frequenza Voltage/frequence Tensión/frecuencia Jännite/taajuus 電源電圧 / 周波数	Vægt Weight Gewicht Vikt Peso/ingombro Poids Peso Paino 重さ	Isolationsklasse Protection Class Schutzklasse Isolationsklass Classe di isolamento Protection au choc électrique Clase de aislamiento Eristysluokka 保護クラス	Tæthedsklasse Ingress protection Schutzart Kapslingsklass Grado di protezione Indice de protection Clase de protección Koteloitiluokka 密度クラス
LED 2,5W 	DC 5V  1.5A SELV	Max. 0,5 kg / 1.1 lbs	Cl. III	IP44

#### DA

Støv aftørres med en tør, blød klud. Fedtpletter og lignende kan fjernes med en blød klud opvredet i lunkent vand (<50° C) tilsat mildt rengøringsmiddel. Brug aldrig rengøringsmidler, der indeholder slibemiddel, opløsningsmidler, alkohol eller syre. Efter udpakning bør lampen oplades inden brug. Genopladelige batterier vedligeholdes bedst ved jævnlig opladning.

#### EN

Wipe off dust with a dry, soft cloth. Remove greasy spots etc. with a soft cloth dampened in lukewarm water (<50° C) with a mild detergent. Never use detergents containing abrasives, solvents, alcohol or acid. After unpacking, the lamp should be charged before use. Rechargeable batteries are best maintained by regular charging.

#### DE

Staub bitte mit einem trockenen, weichen Lappen abwischen. Fettflecke und dgl. mit einem feuchten, in lauwarmem Wasser (<50° C) mit mildem Reinigungsmittel ausgewrungenen Lappen entfernen. Verwenden Sie niemals Reinigungsmittel, die Schleifmittel, Lösungsmittel, Alkohol oder Säure enthalten. Nach dem Auspacken muss die Lampe vor Gebrauch aufgeladen werden. Wiederaufladbare Batterien sollten regelmäßig aufgeladen werden, um ihre Leistungsfähigkeit zu erhalten.

#### SV

Lampan dammtorkas med en torr, mjuk trasa. Fettfläckar tas bort med ljummet vatten (<50° C) utblandat med mildt rengöringsmedel. Använd aldrig rengöringsmedel som innehåller slipmedel, lösningsmedel, alkohol eller syra. Efter uppäckning ska lampan laddas före användning. Laddningsbara batterier underhålls bäst genom regelbunden laddning.

#### IT

Pulire la polvere esterna con un panno morbido e asciutto. Rimuovere macchie di grasso ecc. con un panno morbido inumidito in acqua tiepida (<50° C) e con un detergente leggero. Non utilizzare mai detersivi contenenti abrasivi, solventi, alcool o acidi. Una volta disimballata, la lampada deve essere caricata prima dell'uso. Le batterie ricaricabili si mantengono al meglio ricaricandole periodicamente.

#### FR

Essuyez la poussière avec un chiffon sec et doux. Enlevez les points de saleté etc. avec un chiffon doux imprégné d'eau claire tiède et de détergent doux. N'employez jamais de détergents contenant des substances abrasives, des solvants, de l'alcool ou de l'acide. Après le déballage, la lampe doit être chargée avant utilisation. Il est préférable d'entretenir les batteries rechargeables en les chargeant régulièrement.

#### ES

Limpiar con paño seco y suave. Quitar manchas de grasa y otras con paño suave humedecido con agua templada (<50° C) con detergente poco agresivo. No utilice nunca detergentes que contengan agentes abrasivos, disolventes, alcohol o ácido. Después de desembalarla, la lámpara debe cargarse antes de usarla. Las baterías recargables se conservan mejor cargándolas de forma regular.

#### FI

Pyyhi pölyt kuivalla pehmeällä liinalla. Poista rasvatahrat miedolla pesuaineella ja haalealla vedellä (<50° C) kostutetulla pehmeällä liinalla. Älä koskaan käytä puhdistusaineita, jotka sisältävät hankaavia aineita, liuottimia, alkoholia tai happoa. Kun valaisin on purettu pakkauksesta, se on ladattava ennen käyttöä. Ladattavat akut pysyvät kunnossa parhaiten, kun ne ladataan säännöllisesti.

#### JP

ホコリは乾いた柔らかい布で拭き取ってください。塗装部分の油污れ等は、中性洗剤を溶かしたぬるま湯(50℃以下)に柔らかい布を浸し、よくしぼってから拭き取ってください。シンナー・ベンジン等の揮発物や、つや出し剤・研磨剤、溶剤、アルコール、酸を含む洗剤は絶対に使用しないでください。開梱後、使用前にランプを充電する必要があります。充電式バッテリーは定期的に充電することで最適に保つことができます。



## Replaceability

#### DA

Lyskilden og batteriet i dette armatur kan kun udskiftes med originale reservedele. Producenten opfordrer til at udvise forsigtighed, og at operationen udføres af en kvalificeret person. Reservedele kan købes via Louis Poulsens hjemmeside.

#### EN

The light source and battery contained in this luminaire can be replaced with original spare parts only. The manufacturer encourages to exercise caution and that the operation is performed by a qualified person. Spare parts are available for purchase through the Louis Poulsen website.

#### DE

Die in dieser Leuchte enthaltene Lichtquelle und Batterie dürfen nur durch Originalersatzteile ersetzt werden. Der Hersteller empfiehlt, Vorsicht walten und den Austausch durch eine qualifizierte Person ausführen zu lassen. Ersatzteile sind auf der Website von Louis Poulsen erhältlich.

#### SV

Ljuskällan och batteriet i denna armatur kan endast bytas ut mot originalreservdelar. Tillverkaren rekommenderar att försiktighet iakttas och att bytet utförs av en kvalificerad person. Reservdelar kan köpas via Louis Poulsens webbplats.

#### IT

La sorgente luminosa e la batteria contenute in questo apparecchio di illuminazione possono essere sostituite solo con ricambi originali. Il produttore raccomanda di prestare attenzione e che l'operazione venga eseguita da una persona qualificata. Le parti di ricambio sono disponibili per l'acquisto sul sito web Louis Poulsen.

#### FR

La source lumineuse et la batterie contenues dans ce luminaire ne peuvent être remplacées que par des pièces de rechange d'origine. Le fabricant recommande de faire preuve de prudence et de s'assurer que l'opération est effectuée par une personne qualifiée. Les pièces détachées sont disponibles à l'achat sur le site Internet de Louis Poulsen.

#### ES

La fuente de luz y la batería incluidas en esta lámpara solo pueden sustituirse por piezas de repuesto originales. El fabricante recomienda extremar las precauciones y que la operación sea realizada por una persona cualificada. Las piezas de repuesto están disponibles para su compra en el sitio web de Louis Poulsen.

#### FI

Tämän valaisimen valonlähteen ja akun saa vaihtaa vain alkuperäisiin varaosiin. Valmistajan ohjeiden mukaan varovaisuutta on noudatettava ja vaihdon saa tehdä vain pätevä henkilö. Varaosia voi ostaa Louis Poulsenin verkkosivustolta.

#### KR

이 조명기구에 포함된 광원 및 배터리는 순정 예비 부품으로만 교체할 수 있습니다. 자격을 갖춘 분이 신중하게 작업을 수행하셔야 합니다. 예비 부품은 루이스폴센 웹사이트에서 구매할 수 있습니다.

#### JP

この照明器具に含まれる光源とバッテリーは、純正スペアパーツのみと交換できます。有資格者が慎重に操作を行うことを推奨します。スペアパーツは Louis Poulsen のウェブサイトからご購入いただけます。

#### CN

本灯具中包含的光源和电池只能使用原厂备件更换。制造商鼓励谨慎操作，并确保由合格人员执行操作。可从 Louis Poulsen 网站购买备件。

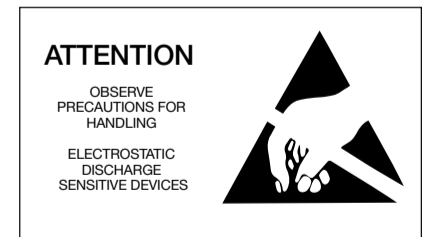
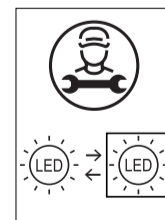

LOUIS POULSEN A/S  
KUGLEGAARDSVEJ 19-23,  
1434 COPENHAGEN K, DENMARK  
TEL. +45 70 33 14 14  
INFO@LOUISPOULSEN.DK  
WWW.LOUISPOULSEN.COM



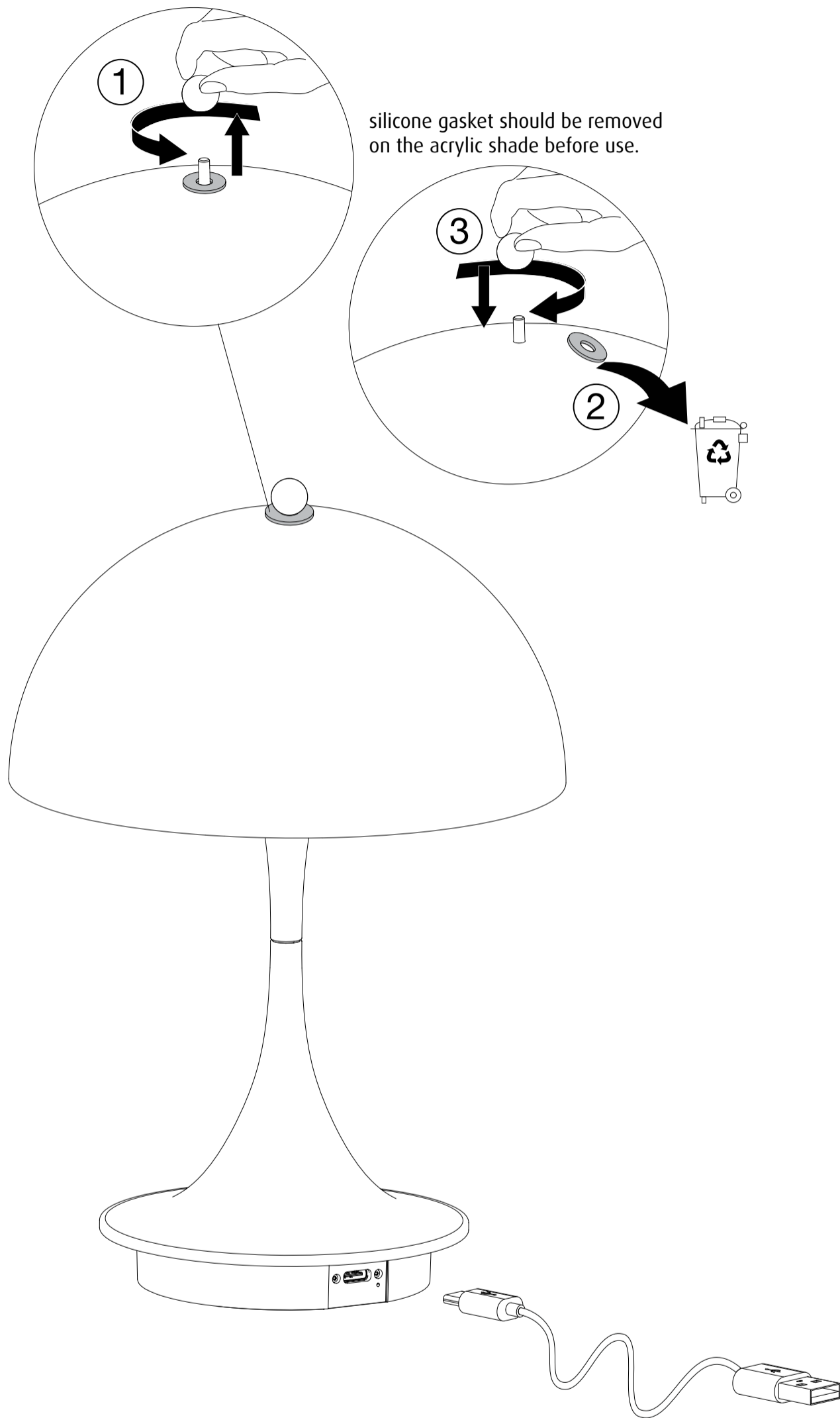
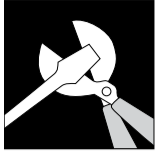

silicone gasket should be removed on the acrylic shade before use.

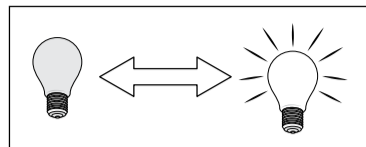
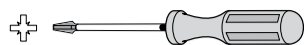
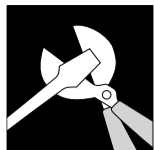

Power on/dimming:

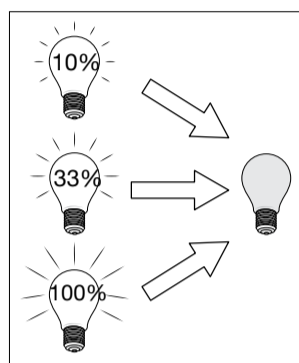
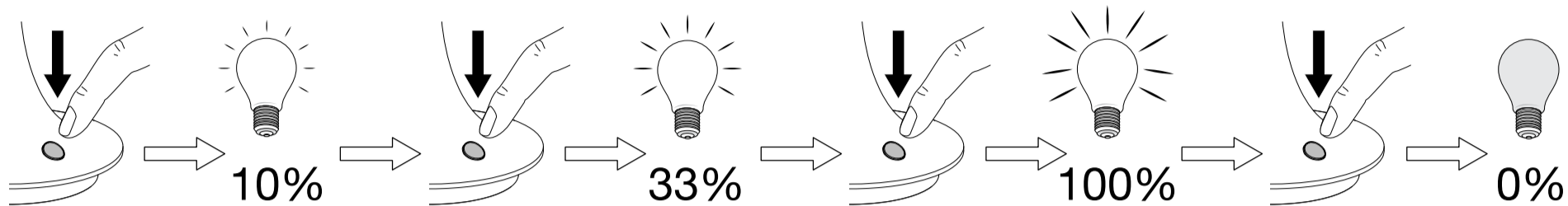

Power off:

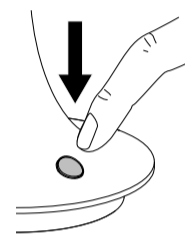

Press and hold 0,5 sec

Lock:

Choose:

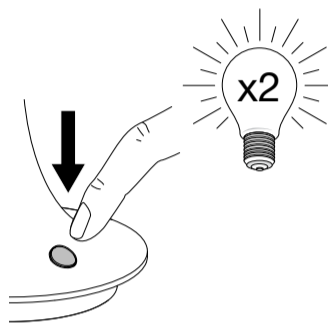

Press and hold >5 sec

Unlock:

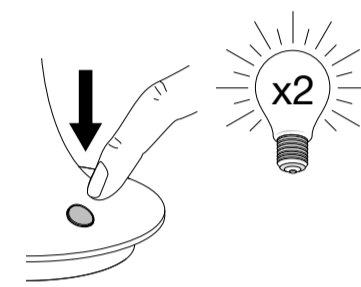

Press and hold >5 sec

Low battery level:

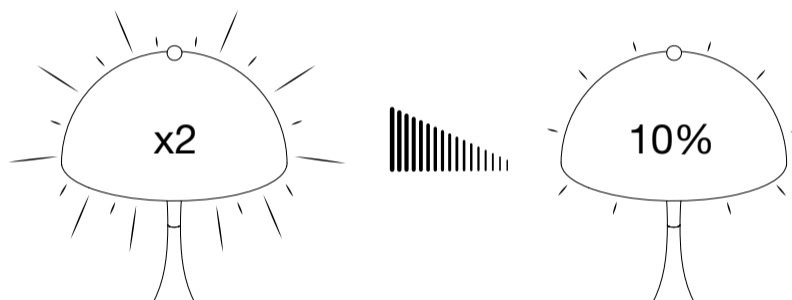

Charging:

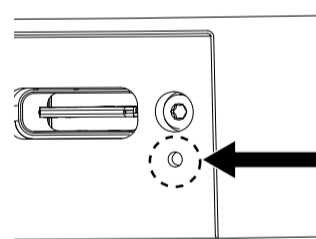
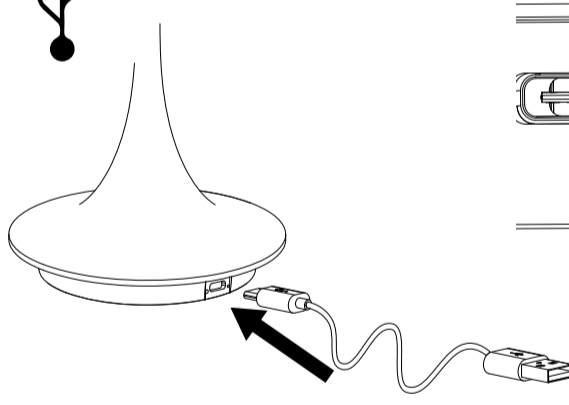
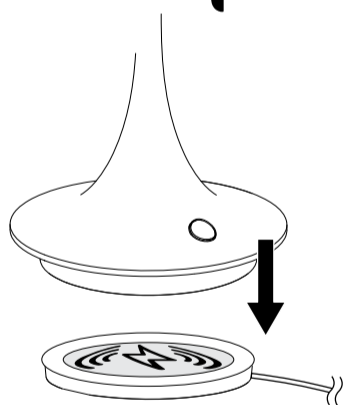

Adapter min. 1.5A

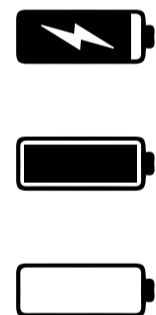

Replace batteries:

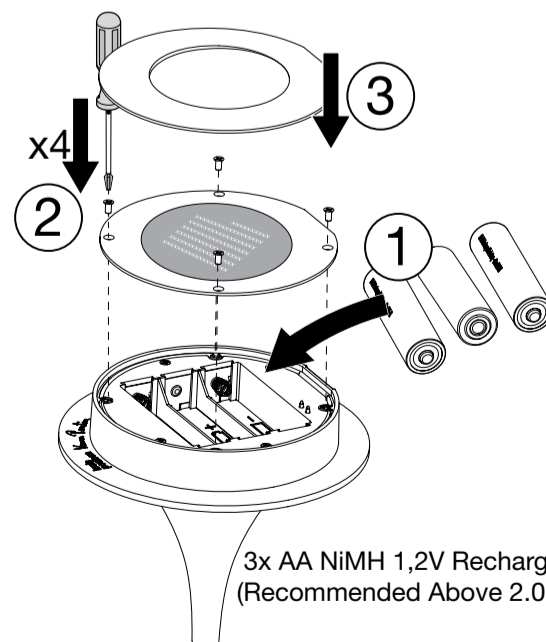
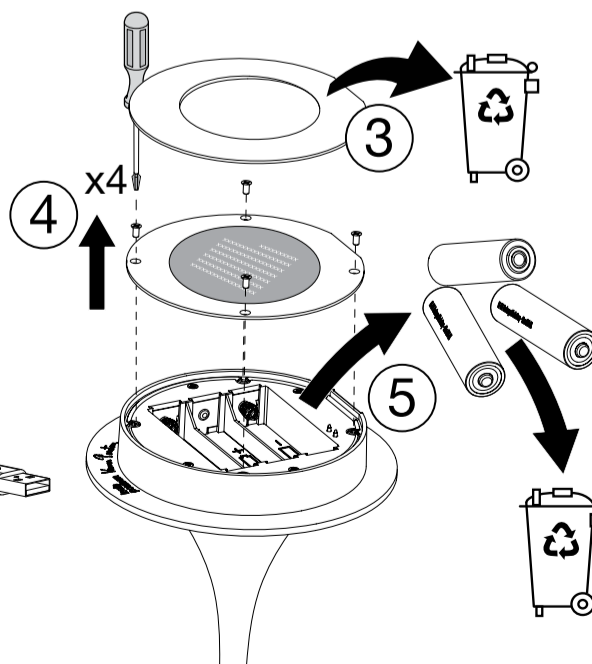
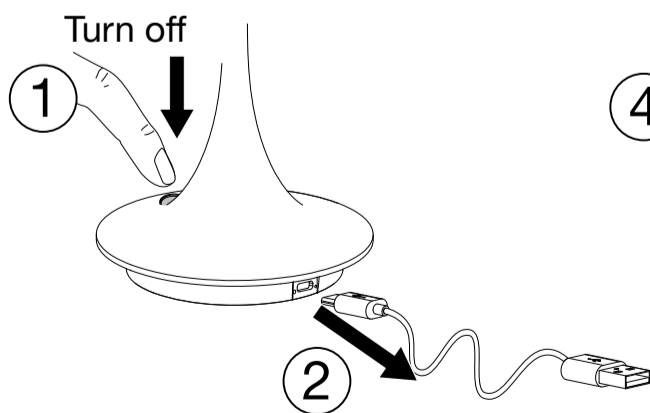

3x AA NiMH 1,2V Rechargeable (Recommended Above 2.000 mAh)

