

300mA Mains Dimmable DRIVER-M-300

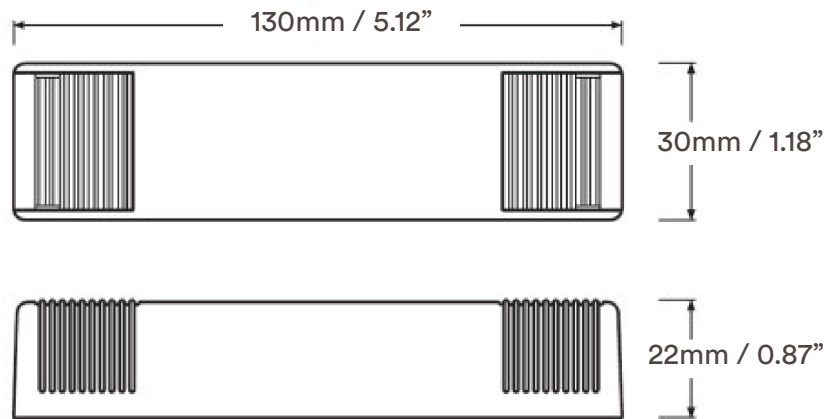
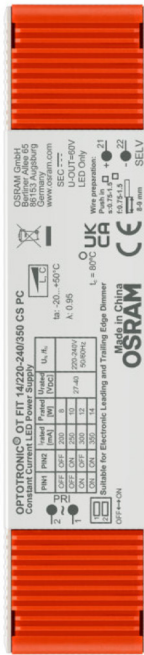

Wiring

Wire + (SEC) to red luminaire cable

Wire - (SEC) to black luminaire cable

Wire 1-2 (PRI) to mains live and neutral cable

Maximum 20m from driver to luminaire

Driver Details

Input Voltage	220 - 240V AC
Control Type	Leading/Trailing
Output current	300mA
Output Voltage	27 - 40V DC
Output Power	5.4 - 14W
Maximum Power	14W
Typical Efficiency	>81%
Power Factor	>0.95
Inrush Current	<10A 100µs

Environment	
Ambient Temperature	-20°C to +50°C
Lifetime	50,000hrs
IP Zone	IP20