

Magdalena, cutting edge *beauty*.

design Bruno Rainaldi
terzani.com

TERZANI
LA LUCE PENSATA



Name
Magdalena
small pendant light

Materials
metal



Finishes | Code

-  white
OM61S E8 C8
-  semipolished nickel plated
OM61S G8 C8
-  gold leaf
OM61S H5 C8

Body

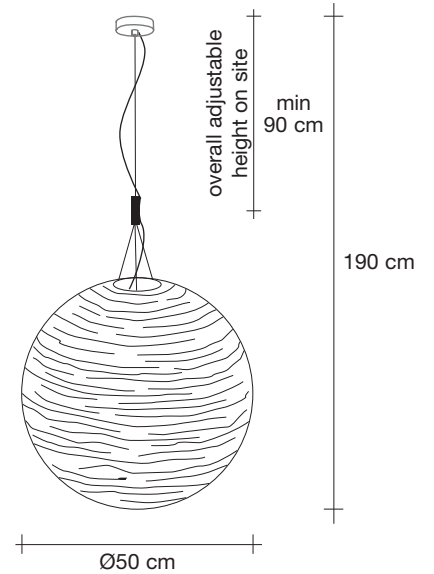

Light source
230-240V ~ 50/60Hz

 LED
15W E27 dimmable

dimmable options

 all systems

Canopy

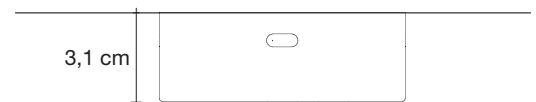
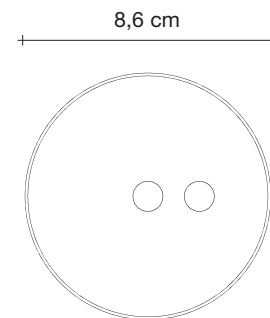

Reaching inside traditional forms, Magdalena's laser-cut, horizontal openings allow for its light to expand its range to the entire room. Creating an alluring pattern of light and shadow, Magdalena highlights the shape of the room itself. This unique exchange creates a pendant that impacts every space, regardless of size. Design Bruno Rainaldi. Made in Italy.

Magdalena, cutting edge *beauty*.

design Bruno Rainaldi
terzani.com

TERZANI
LA LUCE PENSATA



Name
Magdalena
large pendant light

Materials
metal



Finishes | Code

-  white
OM62S E8 C8
-  semipolished nickel plated
OM62S G8 C8
-  gold leaf
OM62S H5 C8

Body

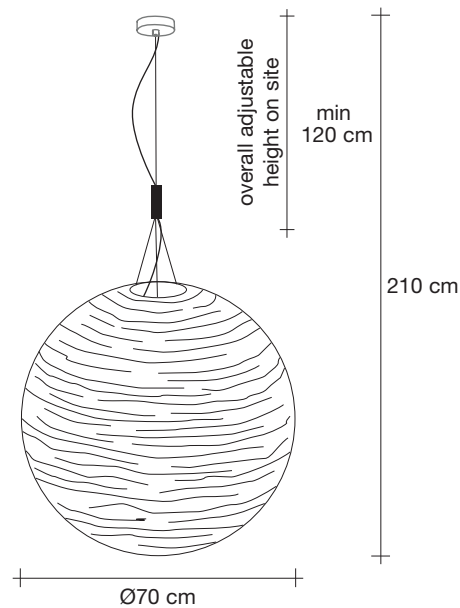

Light source
230-240V ~ 50/60Hz

 LED
15W E27 dimmable

dimnable options

 all systems

Canopy

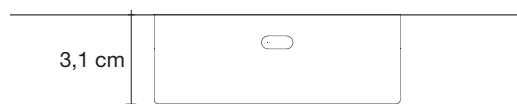
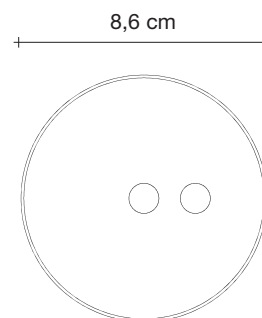

Reaching inside traditional forms, Magdalena's laser-cut, horizontal openings allow for its light to expand its range to the entire room. Creating an alluring pattern of light and shadow, Magdalena highlights the shape of the room itself. This unique exchange creates a pendant that impacts every space, regardless of size. Design Bruno Rainaldi. Made in Italy.

Magdalena, cutting edge *beauty*.

design Bruno Rainaldi
terzani.com

TERZANI
LA LUCE PENSATA



Name

Magdalena
small dome pendant light

Materials

metal



Finishes | Code



semipolished nickel plated
OM65S G8 C8



gold leaf
OM65S H5 C8

Body

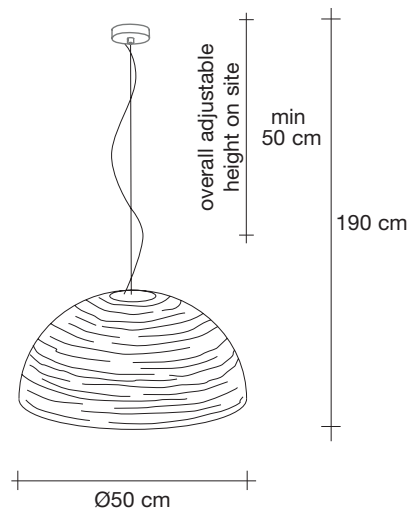

Light source

230-240V ~ 50/60Hz

 LED
15W E27 dimmable

dimmable options

 all systems

Canopy

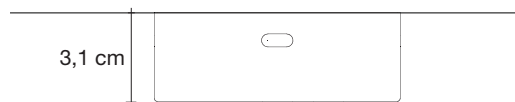
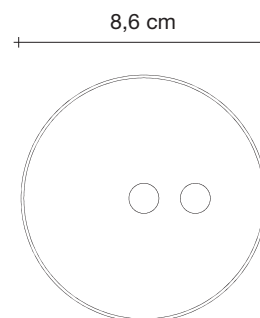

Reaching inside traditional forms, Magdalena's laser-cut, horizontal openings allow for its light to expand its range to the entire room. Creating an alluring pattern of light and shadow, Magdalena highlights the shape of the room itself. This unique exchange creates a pendant that impacts every space, regardless of size. Design Bruno Rainaldi. Made in Italy.

Magdalena, cutting edge *beauty*.

design Bruno Rainaldi
terzani.com



Name
Magdalena
large dome pendant light

Materials
metal



Finishes | Code

-  white
OM66S E8 C8
-  semipolished nickel plated
OM66S G8 C8
-  gold leaf
OM66S H5 C8

Body

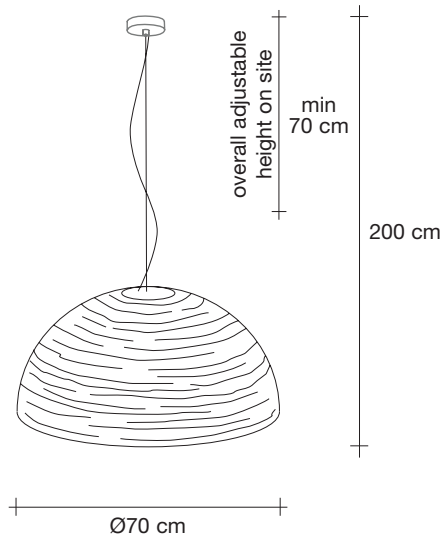

Light source
230-240V ~ 50/60Hz

 LED
15W E27 dimmable

dimnable options

 all systems

Canopy

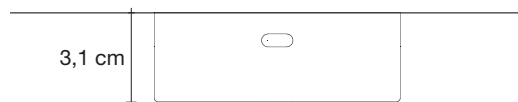
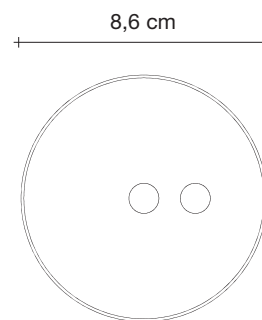

Reaching inside traditional forms, Magdalena's laser-cut, horizontal openings allow for its light to expand its range to the entire room. Creating an alluring pattern of light and shadow, Magdalena highlights the shape of the room itself. This unique exchange creates a pendant that impacts every space, regardless of size. Design Bruno Rainaldi. Made in Italy.