

LAMPE GRAS N°104 BATH DUO

de Bernard-Albin Gras

FICHE TECHNIQUE TECHNICAL SHEET



APPLIQUE

WALL LAMP

Matériau Material	Acier, polycarbonate Steel, polycarbonate
Poids net Net weight	1,3 kg (x2 lamps)
Embase Base	Ø 95 mm
Réflecteur conseillé Recommended shade	M
Emballage (master) Packaging (master)	600x400x300 mm
IP IP	44

Tension Voltage	220/240V
Classe Class	1
Watt Watt	10W
Type d'ampoule Bulb type	E27 LED
Lumens Lumens output	544,20 lm (valeur indicative) 544,20 lm (indicative value)
Driver Driver	NA
Câble Wire	Tissu Fabric
Interrupteur Switch	NA
Fiches Plug	NA

CORPS BODY



Black

BL

COULEURS DES RÉFLECTEURS SHADES COLORS



Black

BL



Polycarbonate
(Round shade only)

PC

RÉFLECTEUR SHADE



LAMPE GRAS (M)

de Bernard-Albin Gras

FICHE TECHNIQUE TECHNICAL SHEET

DONNÉES PHOTOMÉTRIQUES PHOTOMETRIC DATA

Flux **544,20lm**
(valeur indicative)
(indicative value)

Tc **NA**

CRI **NA**

Ampoule testée **E27**
Tested lamp **Led filament**
7 W
806 lumens
2700 K



MEDIUM
ROUND SHADE

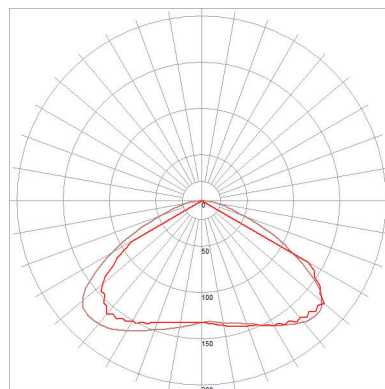

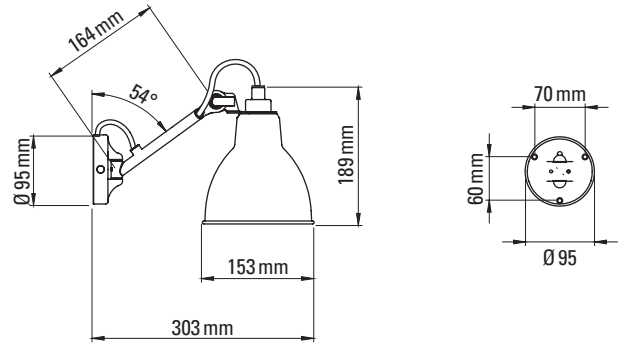

LAMPE GRAS N°104 BATH CLII DUO

de Bernard-Albin Gras

FICHE TECHNIQUE TECHNICAL SHEET



APPLIQUE

WALL LAMP

Matériau Material	Acier, polycarbonate Steel, polycarbonate
Poids net Net weight	1,3 kg (x2 lamps)
Embase Base	Ø 95 mm
Réflecteur conseillé Recommended shade	M
Emballage (master) Packaging (master)	600x400x300 mm
IP IP	44

Tension Voltage	220/240V
Classe Class	2
Watt Watt	10W
Type d'ampoule Bulb type	E27 LED
Lumens Lumens output	544,20 lm (valeur indicative) 544,20 lm (indicative value)
Driver Driver	NA
Câble Wire	Tissu Fabric
Interrupteur Switch	NA
Fiches Plug	NA

CORPS BODY



Black

BL

COULEURS DES RÉFLECTEURS SHADES COLORS



Black

BL



Polycarbonate
(Round shade only)

PC

RÉFLECTEUR SHADE



LAMPE GRAS (M)

de Bernard-Albin Gras

FICHE TECHNIQUE TECHNICAL SHEET

DONNÉES PHOTOMÉTRIQUES PHOTOMETRIC DATA

Flux **544,20lm**
(valeur indicative)
(indicative value)

Tc **NA**

CRI **NA**

Ampoule testée **E27**
Tested lamp **Led filament**
7 W
806 lumens
2700 K



MEDIUM
ROUND SHADE

