

FLOS

F6263000 Transparent

KTribe Table 1

Designed by Philippe Starck, 2007



Halogen - 100W

Table luminaire providing diffused lighting. Base, rod support and diffuser support in die-cast, polished Zamak alloy. Polished aluminum tubular. Injection-molded, matte black PA (Nylon) base cover. Injection-molded PC (polycarbonate) opal inner diffuser. Outer diffuser in transparent or fumée PMMA (polymethylmethacrylate).

Are you a professional and your project needs consulting and support?

[BOOK AN APPOINTMENT](#)

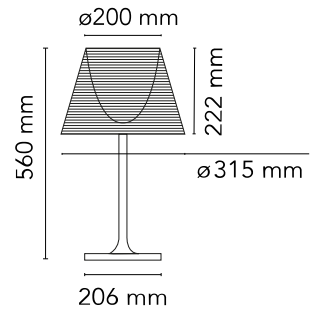

Main specifications

EAN	8059607005637
Mounting	Table
Environments	Indoor dry location
Light Source Type	Bulb
Lamp category	Halogen
Lamp holders	E27
Ilcos	HSGS
Number of heads	1
Power (W)	100

Physical

Colour	Transparent
Cord length (mm)	1640
Net weight (kg)	3.13
Package volume (m3)	0.09
IP internal	20

Download

[Mounting instructions](#) PDF

[Spare Parts](#) PDF

Photometric Files

[LDT / IES](#) LDT

Technical Drawings

[2D](#) ZIP

[3D](#) ZIP



Schematic light drawing

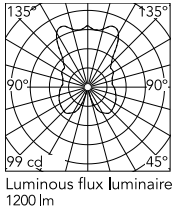

Photometric

Lighting type	Indirect, Direct
Light distribution	Symmetric

Electrical

Insulation class	II
Frequency (Hz)	50/60
Main voltage (Vac)	220-240
LED voltage Vf (Vdc)	null
Dimmable	Yes
Dimming interface	Dimmer Integrated
Plug type	Type C
Batteries inside	No
Charging min time	No

Bulbs

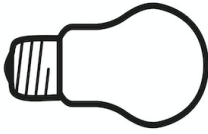

NOT INCLUDED

RF32563

LED Lamp 11.5W E27 220-240V
2700K A70



NOT INCLUDED

RF32564

LED Lamp 11.5W E27 220-240V
3000K A70

Spare Parts

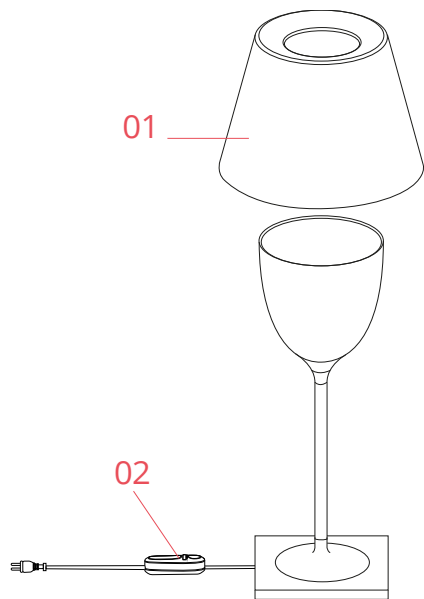

01. Ktribe Table 1 transparent
diffuser assembly

F6264000

DOWNLOAD



F6264000

Ktribe Table 1 transparent
diffuser assembly

FLOS

F6303000 Transparent

KTribe Table 2

Designed by Philippe Starck, 2007

Halogen - 150W



Table luminaire providing diffused lighting. Base, rod support and diffuser support in diecast, polished and chrome-plated Zamak alloy. Base cover in black injection-molded PA (Nylon). Injection-molded PC (polycarbonate) opal inner diffuser. Outer diffusers in transparent or fumée PMMA (polymethylmethacrylate), and silver or bronze on the inner surface, by vacuum aluminum coating. Injection-molded PC (polycarbonate) upper ring, completely transparent or transparent diffuser and silver diffuser) or transparent brown for the outer bronze diffuser.

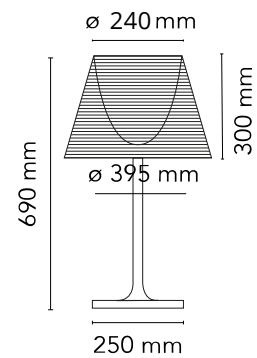

Are you a professional and your project needs consulting and support?

[BOOK AN APPOINTMENT](#)

Main specifications

EAN	8059607005965
Mounting	Table
Environments	Indoor dry location
Light Source Type	Bulb
Lamp category	Halogen
Lamp holders	E27
Ilcos	HSGS
Number of heads	1
Power (W)	150

Physical

Colour	Transparent
Cord length (mm)	1640
Net weight (kg)	4.5
Package volume (m3)	0.18
IP internal	20

Download

[Mounting instructions](#) PDF

[Spare Parts](#) PDF

Photometric Files

[LDT / IES](#) LDT

Technical Drawings

[2D](#) ZIP

[3D](#) ZIP



Schematic light drawing

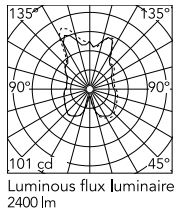

Photometric

Lighting type	Indirect, Direct
Light distribution	Symmetric

Electrical

Insulation class	II
Frequency (Hz)	50/60
Main voltage (Vac)	220-240
LED voltage Vf (Vdc)	null
Dimmable	Yes
Dimming interface	Dimmer Integrated
Plug type	Type C
Batteries inside	No
Charging min time	No

Bulbs



NOT INCLUDED

RF32288

LED Lamp E27 15W 2700K T38



NOT INCLUDED

RF32289

LED Lamp E27 15W 3000K T38

Spare Parts

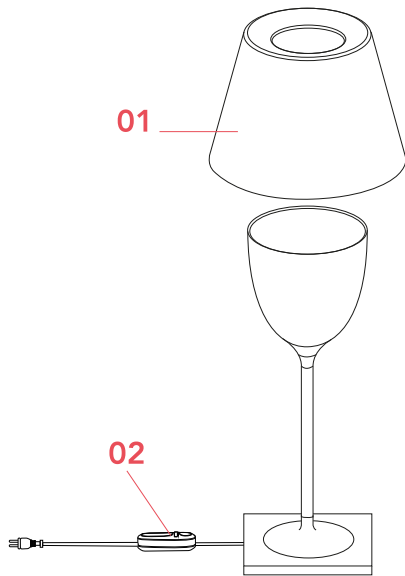

01. Ktribe Floor/Table 2 fumée
diffuser assembly

F6278000

DOWNLOAD



F6278000

Ktribe Floor/Table 2 fumée
diffuser assembly