

INSTALLATION MANUAL

GEOMETRIC PC1150

Pendent light



COMPONENTS OF PACKAGING:

ceiling bracket with electronics and wire rope stops, ceiling canopy, light assembly, hex key (size 2.5), 2 set screws (M5), plastic cable stop, cotton gloves, installation manual

WARNING:

Installation must be carried out by a qualified electrician only.

Switch off power at main circuit panel prior to installation!

The manufacturer assumes no liability for damage occurring in transport or resulting from incorrect installation.

Installation time: 30 minutes/2 persons

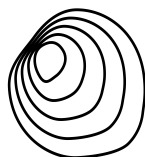

BROKIS®

BROKIS S.R.O.
ŠPANIĚLOVA 1315/25
163 00 PRAHA 6 - ŘEPY
CZECH REPUBLIC

ORG. ID 64940799
VAT ID CZ64940799
C 42174 MĚSTSKÝ SOUD
V PRAZE

TEL +420 567 211 517
TECHNICAL@BROKIS.CZ
INFO@BROKIS.CZ
WWW.BROKIS.CZ

1. INSTALLING THE CEILING BRACKET

Use anchors of sufficient strength only (not included with unit) and secure the bracket to the ceiling. With regard for various types of ceilings, we recommend consulting installation with an expert. The manufacturer assumes no liability for incorrect installation or defects in the material to which the bracket is secured.

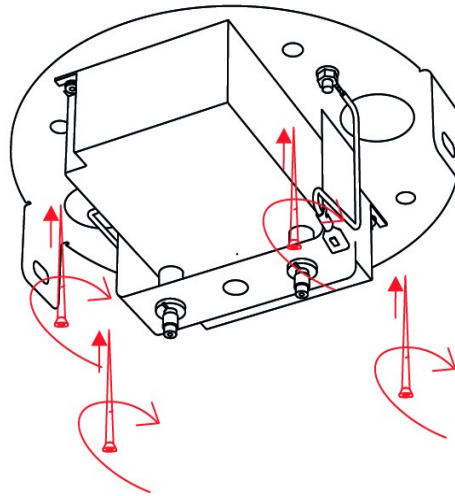

2. INSTALLING THE LIGHT

Pass the textile power cable and two wire ropes through the metal ceiling canopy. Pass the wire rope through the first part of the anchor, the so-called safety. Next, pass the unfrayed wire rope through the second part of the anchor attached to the ceiling bracket and then level the light.

Once the light is level, screw the safety into position!!!

Never cut the wire rope prior to completing installation! Adhering to these steps ensures safe anchoring of the wire rope, which bears the entire weight of the light.

Secure the power cable in the ceiling canopy with the plastic cable stop.

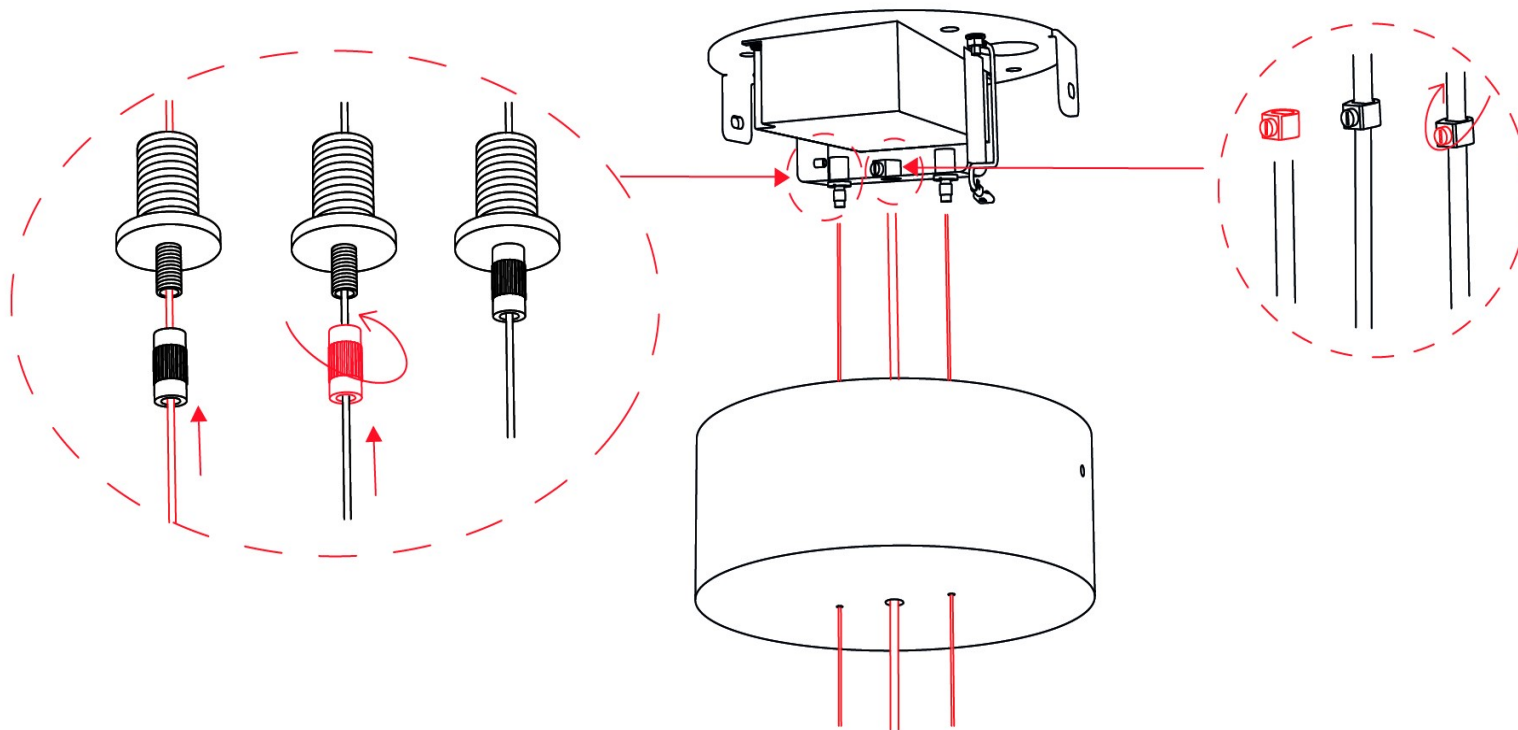

3. CONNECTING THE LIGHT TO THE BUILDING WIRING

Connect the light to the building wiring according to the connection diagram.

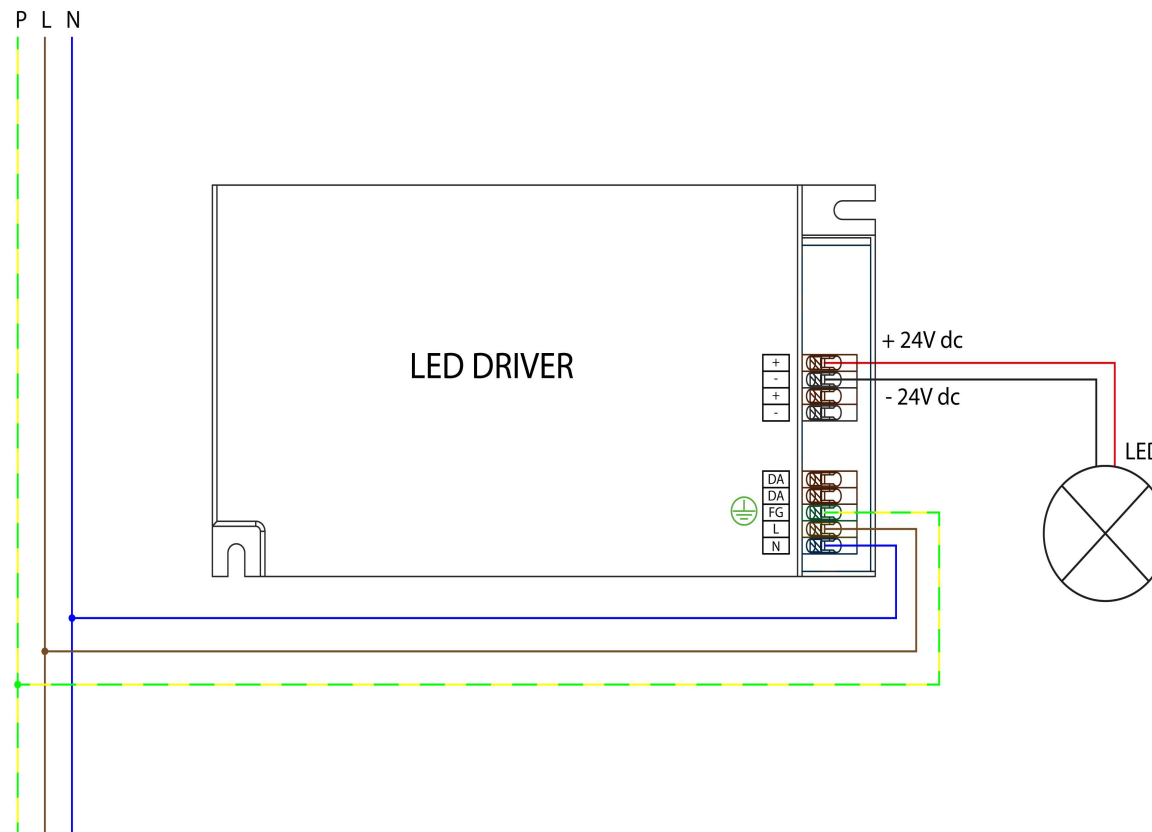

4. INSTALLING THE CEILING CANOPY

Attach the ground wire to the ceiling canopy using the connector!

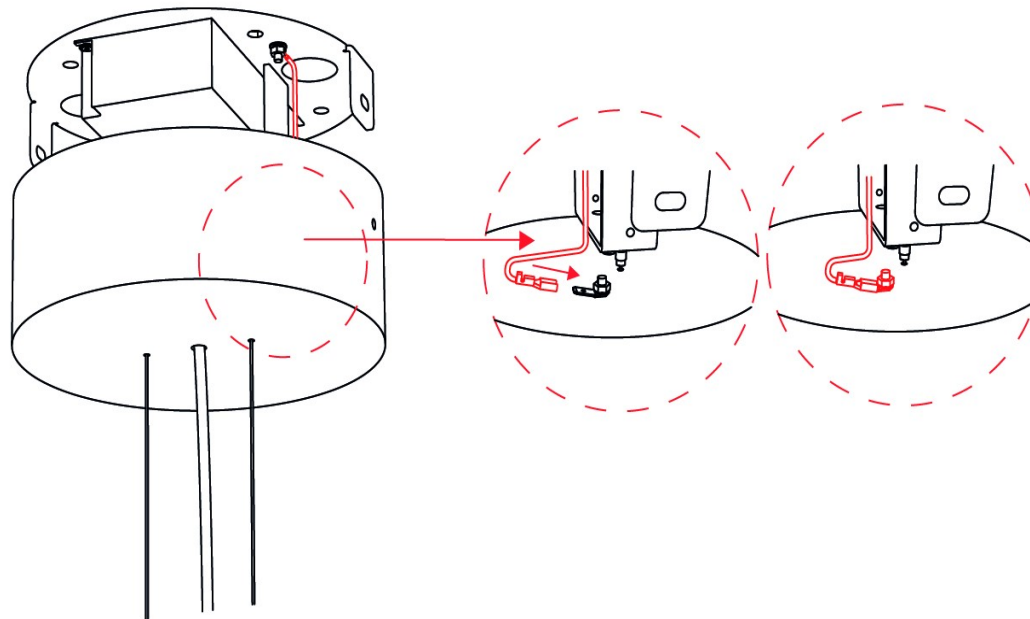

5. INSTALLING THE CEILING CANOPY

Use the two hex screws and the hex key to secure the ceiling canopy to the bracket. Do not sink the screws into the ceiling canopy – we recommend installing them so that they extend from the ceiling canopy by at least 1 mm.

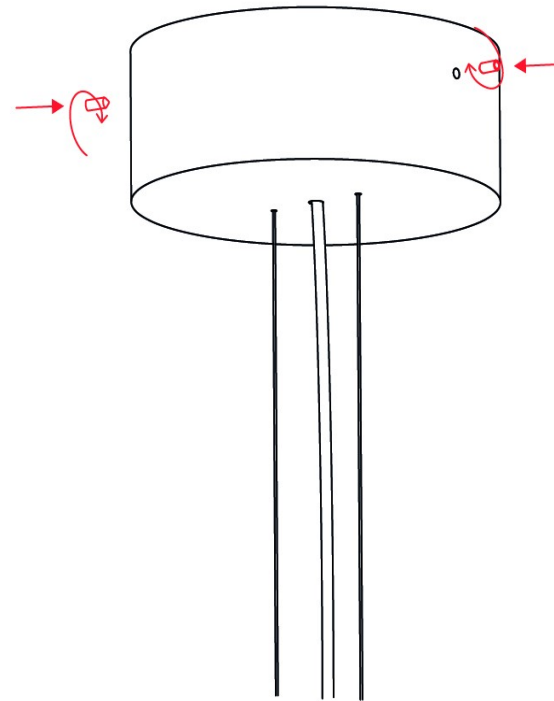
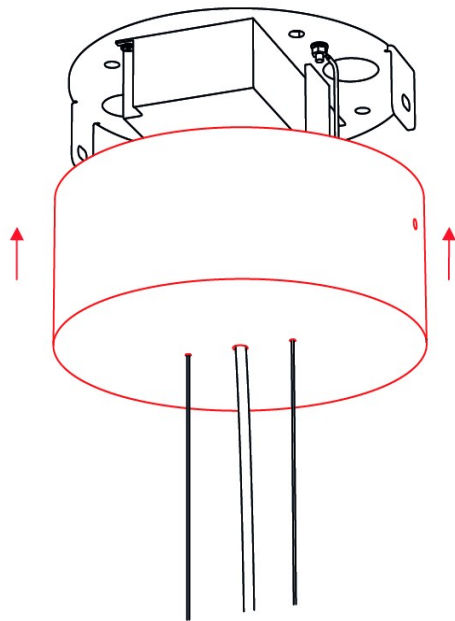

6. SWITCHING ON THE LIGHT

Restore power at the main circuit panel and verify that the light works properly.

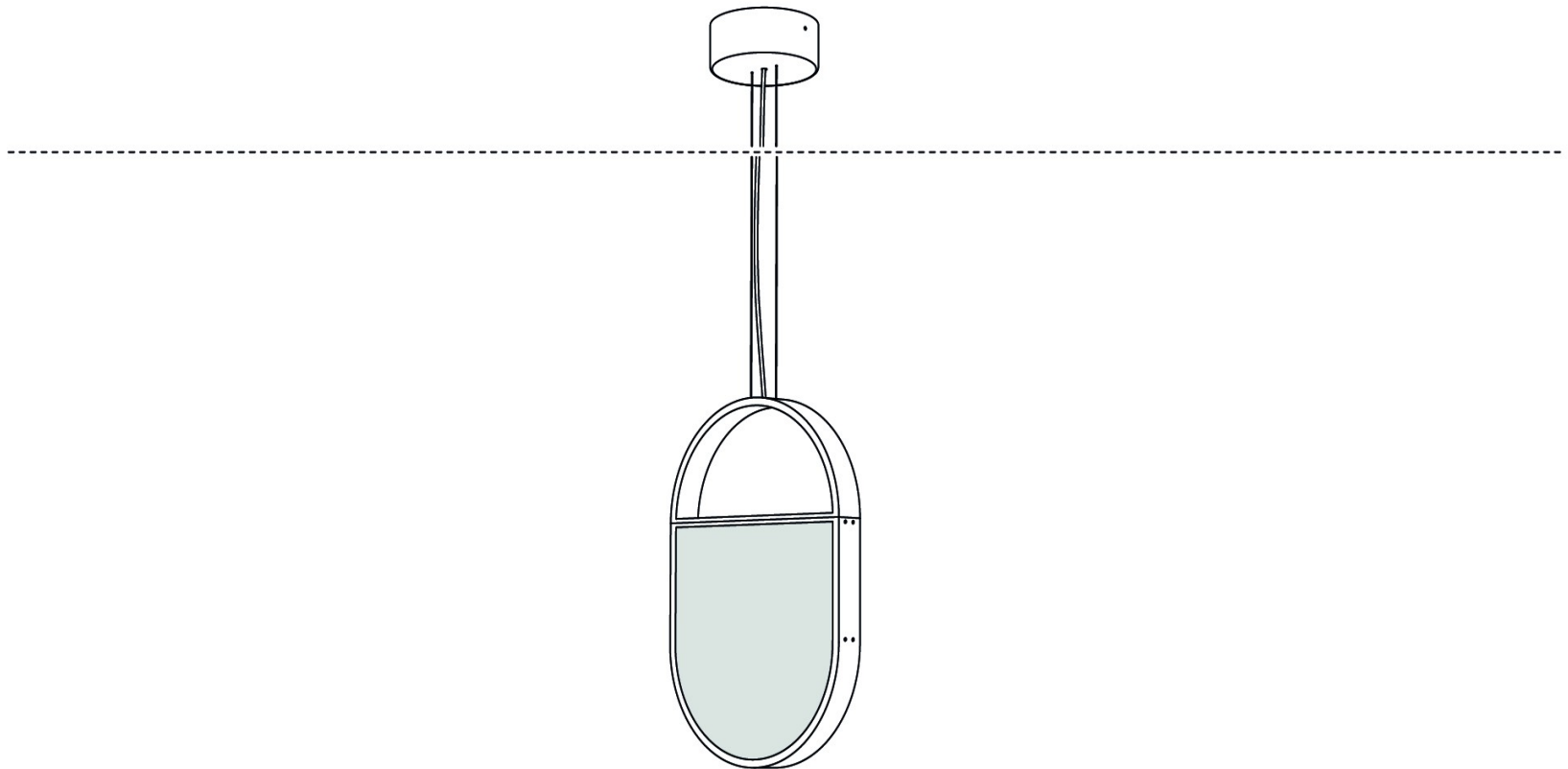



CLEANING THE GLASS

The light can be cleaned using common cleaning agents. Never use solvents or abrasives (scouring powder).

PRIOR TO SHIPPING, THE FUNCTIONALITY OF EACH LIGHT AND ITS COMPONENTS IS THOROUGHLY TESTED. THE MANUFACTURER ASSUMES NO LIABILITY FOR THE MISHANDLING OF PRODUCTS.

CM12398

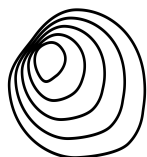

BROKIS®

BROKIS S.R.O.
ŠPANIĚLOVA 1315/25
163 00 PRAHA 6 - ŘEPY
CZECH REPUBLIC

ORG. ID 64940799
VAT ID CZ64940799
C 42174 MĚSTSKÝ SOUD
V PRAZE

TEL +420 567 211 517
TECHNICAL@BROKIS.CZ
INFO@BROKIS.CZ
WWW.BROKIS.CZ