



BROKIS®



CM14132

DOME NOMAD

SMALL PC1265, SMALL LINES PC1287



Download

COMPONENTS INCLUDED WITH UNIT:

1x assembled light
1x pair cotton gloves
1x installation manual
1x charging cable
1x hex key size 6
1x wrench size 7

WARNING:

The manufacturer assumes no liability for damage resulting from incorrect assembly. When unpacking the light, do so with regard for its material composition – the main components are made of glass. Wear the cotton gloves included with the light when unpacking and assembling it. The light must be charged before first use.

EXERCISE EXTRA CARE WHEN MOVING THE LIGHT. THE LIGHT MUST BE SUPPORTED FROM BENEATH AT ALL TIMES AND MUST NEVER BE PICKED UP BY THE TOP RING ONLY. THE MANUFACTURER WILL NOT ACCEPT DAMAGE CLAIMS ARISING FROM INCORRECT HANDLING.

Installation time: 5 minutes / 1 person



BROKIS®

BROKIS S.R.O.
ŠPANILOVA 1315/25
163 00 PRAHA 6 - ŘEPY
CZECH REPUBLIC

ORG. ID 64940799
VAT ID CZ64940799
C 42174 MĚSTSKÝ SOUD
V PRAZE

TEL +420 567 211 517
TECHNICAL@BROKIS.CZ
INFO@BROKIS.CZ
WWW.BROKIS.CZ



CLEANING THE GLASS:

BROKIS upholds only the highest possible quality standards. Prior to shipping, the light undergoes several quality controls and stages of cleaning. Because transportation, storage, and the amount of time that passes between packing at our plant and subsequent unpacking by the client can affect the light in different ways, we strongly recommend cleaning it prior to assembly.

The glass must first be rinsed in warm water, and a dish detergent may be used to remove all foreign particles, dust, and grease. Repeat the process if necessary and then dry the glass thoroughly with a paper towel.

Recommendation: Do not use mineral spirits, highly concentrated thinners, or other substances not intended for use on glass surfaces. Do not use any cleaning agents containing silicone, as they may leave a film and attract dust and smudges.

PRIOR TO SHIPPING, THE FUNCTIONALITY OF THE LIGHT AND ITS COMPONENTS ARE CHECKED THOROUGHLY. THE MANUFACTURER ASSUMES NO LIABILITY FOR THE MISHANDLING OF PRODUCTS.



1. SWITCHING THE LIGHT ON AND OFF / DIMMING

Place a finger on the side of the base to switch the light on and off or adjust the brightness.

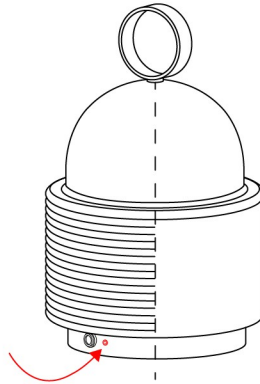

2. CLEANING / DISASSEMBLING THE LIGHT AND REPLACING THE GLASS 1/3

Prior to cleaning the internal parts, the light must be disconnected from all power sources.

Place the light on its side on a soft surface to prevent damage to the glass. Use the supplied size 6 hex key to remove the M10 screw from the bottom of the light. Next, tilt the metal cover out and disconnect the ground wire. Thread the screw back into the hole, turning it 3–4 times. In the next step, the screw will be used to hold the heat sink with light source in the upright position.

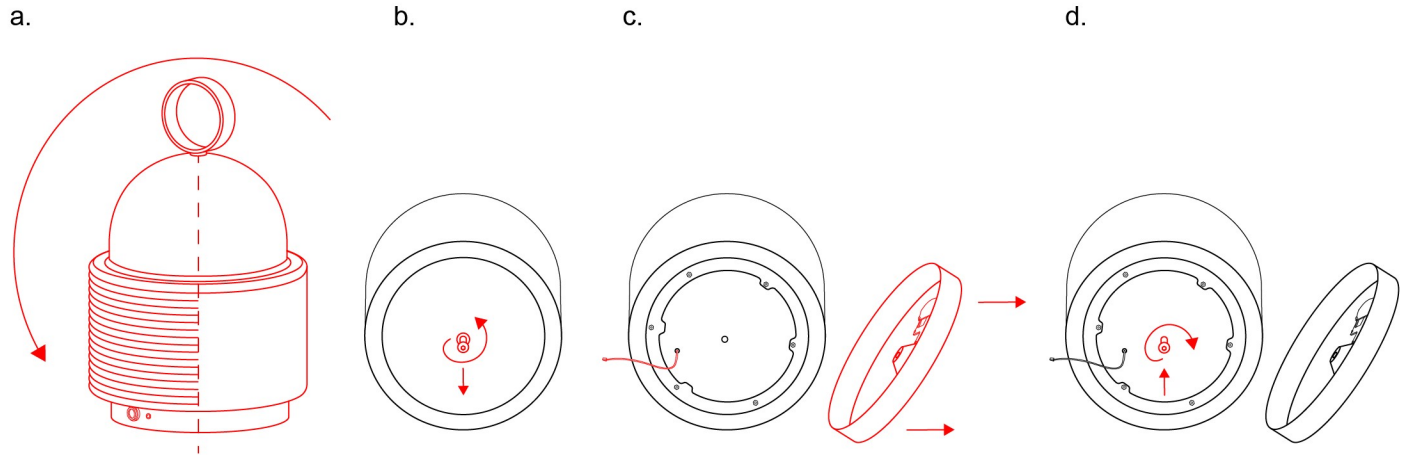

3. CLEANING / DISASSEMBLING THE LIGHT AND REPLACING THE GLASS 2/3

Holding the centre screw firmly to prevent damage to the light, use the supplied size 7 wrench to remove the M4 nuts around the circumference of the heat sink and then remove the stainless-steel ring. Do not let go of the screw!

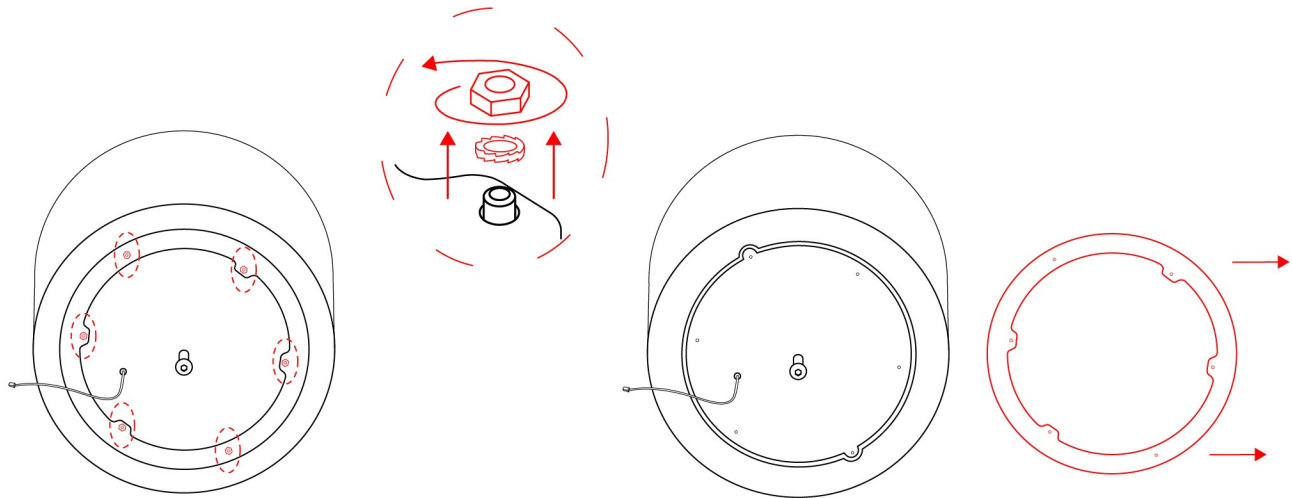

4. CLEANING / DISASSEMBLING THE LIGHT AND REPLACING THE GLASS 3/3

Holding the heat sink with light source in the upright position, move it into the glass shade, turn it sideways 90 degrees, and then pull it out through the indentations in the glass.

After cleaning, reassemble the light by following the steps in reverse order.

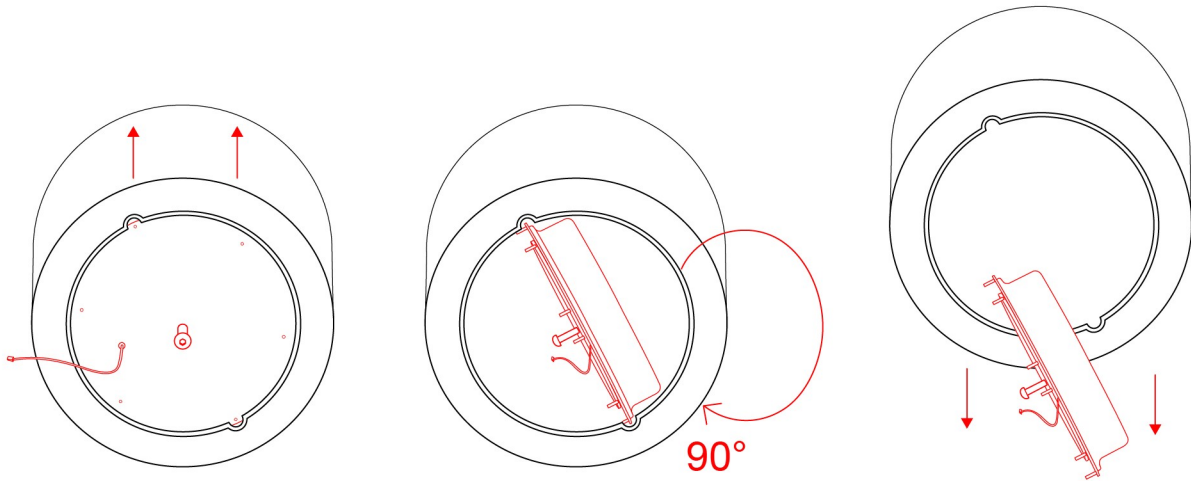

5. CHARGING THE LIGHT

Charge the light by placing the magnetic connector of the charging cable on the light.

Charging is indicated by a blinking green diode, which changes to solid green when charging is complete.

Time to full charge: 6.5 hours

Battery life from full charge: 4.5 hours

Recommended charging adapter: 5V / 1.4A

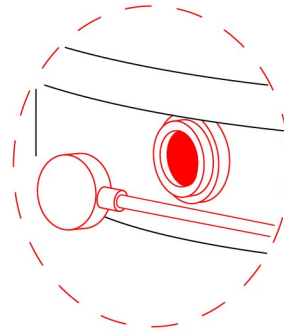
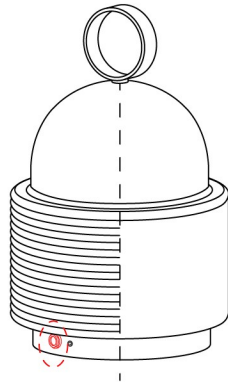

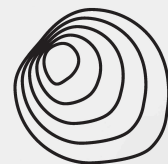

BROKIS®



CM14134

DOME NOMAD

LARGE PC1266, LARGE LINES PC1288



Download

COMPONENTS INCLUDED WITH UNIT:

1x assembled light
1x pair cotton gloves
1x installation manual
1x charging cable (Magconn M10PC - RXC2M)
1x hex key size 6
1x wrench size 7

WARNING:

The manufacturer assumes no liability for damage resulting from incorrect assembly. When unpacking the light, do so with regard for its material composition – the main components are made of glass. Wear the cotton gloves included with the light when unpacking and assembling it. The light must be charged before first use.

EXERCISE EXTRA CARE WHEN MOVING THE LIGHT. THE LIGHT MUST BE SUPPORTED FROM BENEATH AT ALL TIMES AND MUST NEVER BE PICKED UP BY THE TOP RING ONLY. THE MANUFACTURER WILL NOT ACCEPT DAMAGE CLAIMS ARISING FROM INCORRECT HANDLING.

Installation time: 5 minutes / 1 person



BROKIS®

BROKIS S.R.O.
ŠPANILOVA 1315/25
163 00 PRAHA 6 - ŘEPY
CZECH REPUBLIC

ORG. ID 64940799
VAT ID CZ64940799
C 42174 MĚSTSKÝ SOUD
V PRAZE

TEL +420 567 211 517
TECHNICAL@BROKIS.CZ
INFO@BROKIS.CZ
WWW.BROKIS.CZ



CLEANING THE GLASS:

BROKIS upholds only the highest possible quality standards. Prior to shipping, the light undergoes several quality controls and stages of cleaning. Because transportation, storage, and the amount of time that passes between packing at our plant and subsequent unpacking by the client can affect the light in different ways, we strongly recommend cleaning it prior to assembly.

The glass must first be rinsed in warm water, and a dish detergent may be used to remove all foreign particles, dust, and grease. Repeat the process if necessary and then dry the glass thoroughly with a paper towel.

Recommendation: Do not use mineral spirits, highly concentrated thinners, or other substances not intended for use on glass surfaces. Do not use any cleaning agents containing silicone, as they may leave a film and attract dust and smudges.

PRIOR TO SHIPPING, THE FUNCTIONALITY OF THE LIGHT AND ITS COMPONENTS ARE CHECKED THOROUGHLY. THE MANUFACTURER ASSUMES NO LIABILITY FOR THE MISHANDLING OF PRODUCTS.



1. SWITCHING THE LIGHT ON AND OFF / DIMMING

Place a finger on the side of the base to switch the light on and off or adjust the brightness.

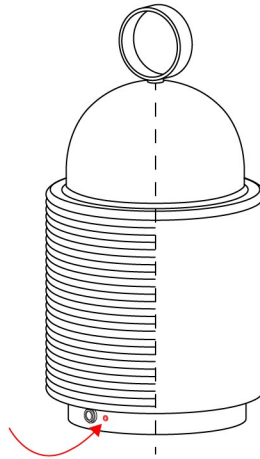

2. CLEANING / DISASSEMBLING THE LIGHT AND REPLACING THE GLASS 1/3

Prior to cleaning the internal parts, the light must be disconnected from all power sources.

Place the light on its side on a soft surface to prevent damage to the glass. Use the supplied size 6 hex key to remove the M10 screw from the bottom of the light. Next, tilt the metal cover out and disconnect the ground wire. Thread the screw back into the hole, turning it 3–4 times. In the next step, the screw will be used to hold the heat sink with light source in the upright position.

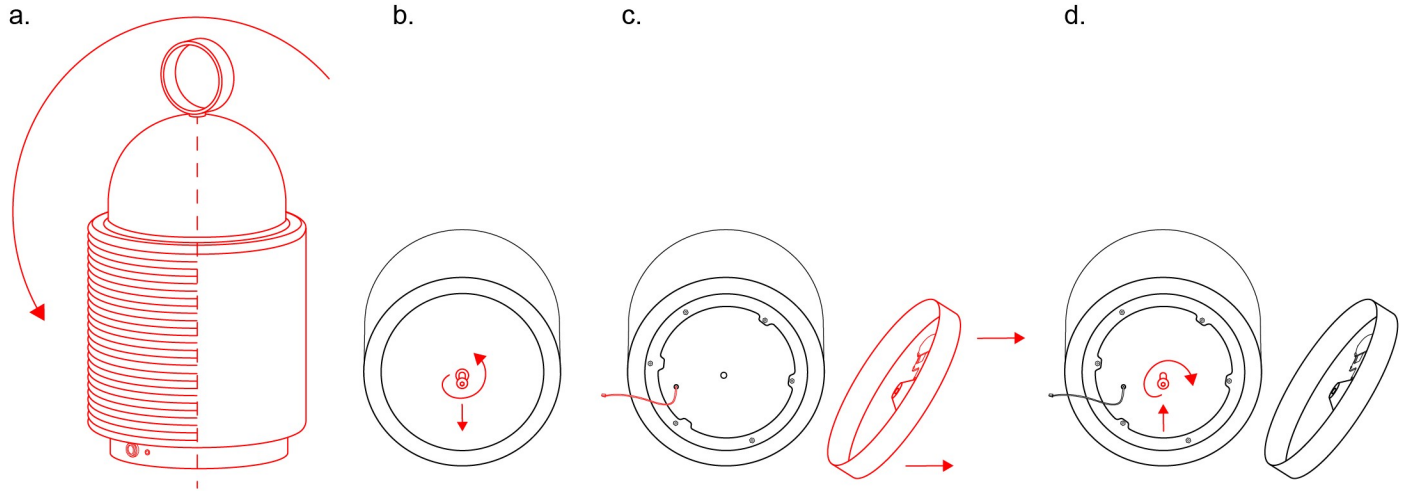

3. CLEANING / DISASSEMBLING THE LIGHT AND REPLACING THE GLASS 2/3

Holding the centre screw firmly to prevent damage to the light, use the supplied size 7 wrench to remove the M4 nuts around the circumference of the heat sink and then remove the stainless-steel ring. Do not let go of the screw!

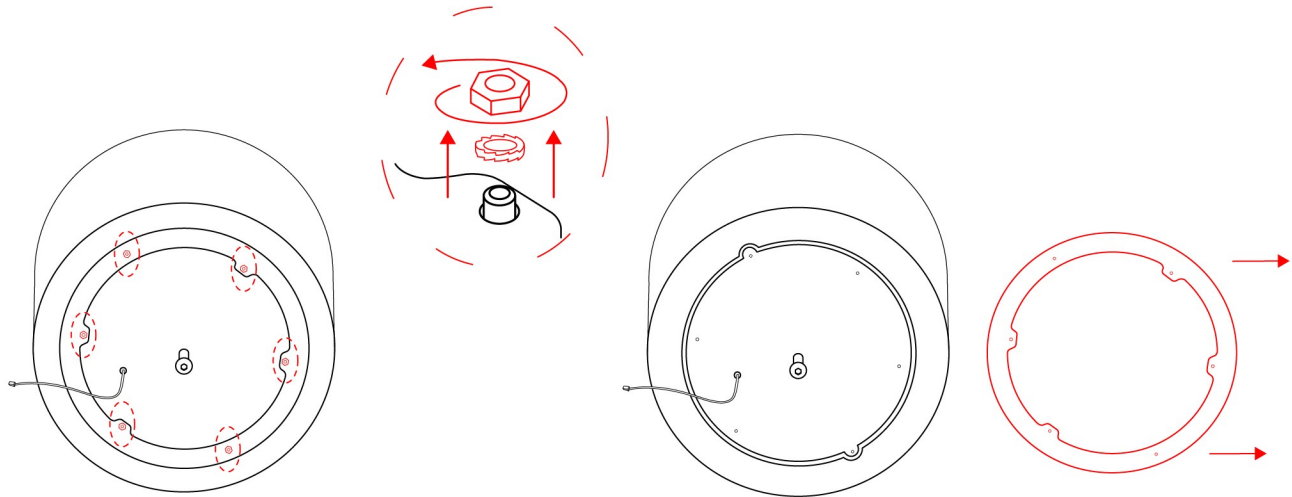

4. CLEANING / DISASSEMBLING THE LIGHT AND REPLACING THE GLASS 3/3

Holding the heat sink with light source in the upright position, move it into the glass shade, turn it sideways 90 degrees, and then pull it out through the indentations in the glass.

After cleaning, reassemble the light by following the steps in reverse order.

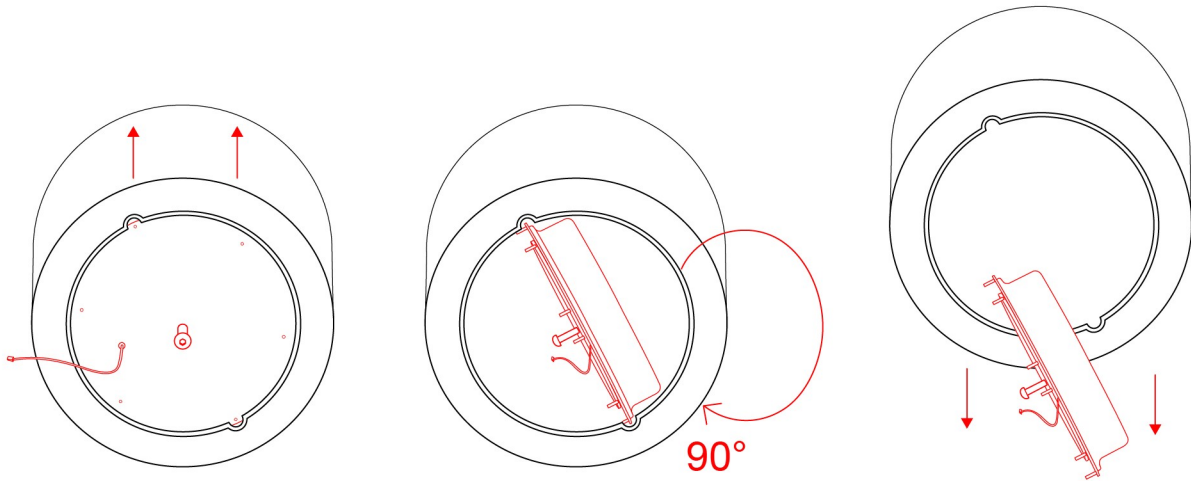

5. CHARGING THE LIGHT

Charge the light by placing the magnetic connector of the charging cable on the light.

Charging is indicated by a blinking green diode, which changes to solid green when charging is complete.

Time to full charge: 6.5 hours

Battery life from full charge: 4.5 hours

Recommended charging adapter: 5V / 1.4A

