

Break plus

VIBIA





4112

Design By Xuclà

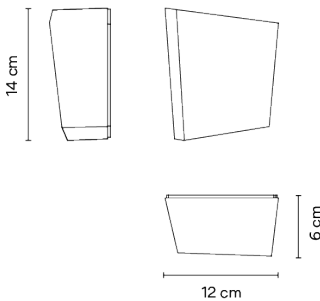
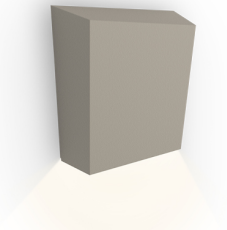
The Break Plus outdoor wall lamp resembles a tile or a brick and is designed to be integrated in the architecture of all types of space. Its matt lacquered finish adds a grainy quality that complements its geometric shape.

Model Sheet



Finish	 95 Primer NCS S 1000-N
	 22 Graphite Black NCS S 8000-N
	 25 Beige D1 NCS S 4005-Y50R
	 37 Terra Red NCS S 4040-Y70R

LED temperature color 2700 K / 3500 K

Dimming On/ Off

Materials Body: Aluminum
Diffuser: Polycarbonate

Light source 1 x LED 1W 350mA



LED CRI>90 113,73
2700 K / 3500 K

Driver Constant Current 100~240 V V
50~60 Hz HZ



Application Outdoor lamps

Packaging 1 Box
0.23 m x 0.19 m x 0.07 m
Gross weight 1
Net weight 0.61
Vol. 0.003

Lighting effect

General Lighting

Reduced-height outdoor lamp to shade light on the ground.



Photometric Data

Go to vibia.com to get the photometric data for the different LED color temperatures.

Efficiency	33,50 lm/W
Coordinate System	CG
Total Flux	55,82 lm
Maximum Value	22,11 cd

Other Applications

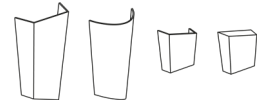

All of our products come with a five-year warranty. Check our legal terms at www.vibia.com/warranty

Vibia Lighting, S.L.U.

Office / Oficina
Progrés 4-6. 08850 Gavà. Barcelona, Spain.

International T +34 934 796 971
Spain / Portugal T +34 934 796 970

customer.service@vibia.com
vibia.com

Break plus

VIBIA





4114

Design By Xuclà

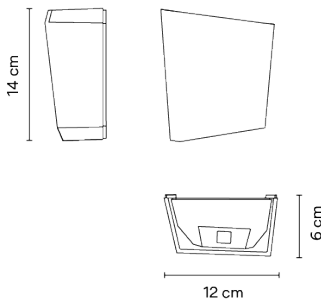
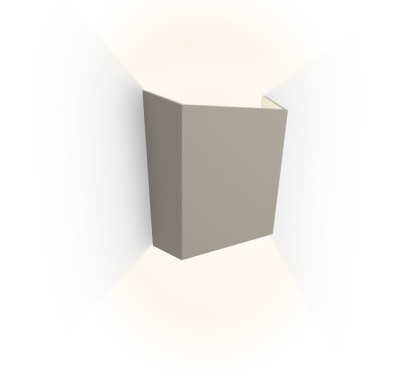
Break Plus is an outdoor wall lamp that resembles a tile or a brick, designed to be integrated in the architecture of all types of space. Its beam of light shines in two directions. The lamp's matt lacquered finish adds a grainy quality that complements its geometric shape.

Model Sheet



Finish	 25 Beige D1 NCS S 4005-Y50R
	 95 Primer NCS S 1000-N
	 22 Graphite Black NCS S 8000-N
	 37 Terra Red NCS S 4040-Y70R

LED temperature color 2700 K / 3500 K

Dimming On/ Off

Materials Body: Aluminum
Diffuser: Polycarbonate

Light source 2 x LED 1W 350mA



LED CRI>90 113,73
2700 K / 3500 K

Driver Constant Current 100~240 V V
50~60 Hz HZ



Application Outdoor lamps

Packaging 1 Box
0.23 m x 0.19 m x 0.07 m
Gross weight 1
Net weight 0.59
Vol. 0.003

Lighting effect

General Lighting

Reduced-height outdoor lamp to shade light on the ground.



Photometric Data

Go to vibia.com to get the photometric data for the different LED color temperatures.

Efficiency	29.69 lm/W
Coordinate System	CG
Total Flux	85.57 lm
Maximum Value	19.23 cd

Other Applications

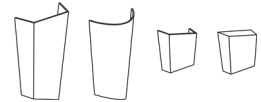

All of our products come with a five-year warranty. Check our legal terms at www.vibia.com/warranty

Vibia Lighting, S.L.U.

Office / Oficina
Progrés 4-6. 08850 Gavà. Barcelona, Spain.

International T +34 934 796 971
Spain / Portugal T +34 934 796 970

customer.service@vibia.com
vibia.com

Break plus

VIBIA





4116

Design By Xuclà

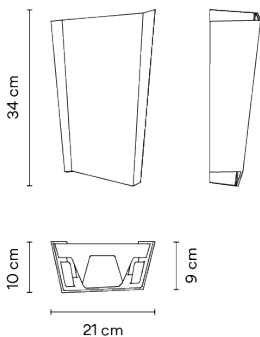
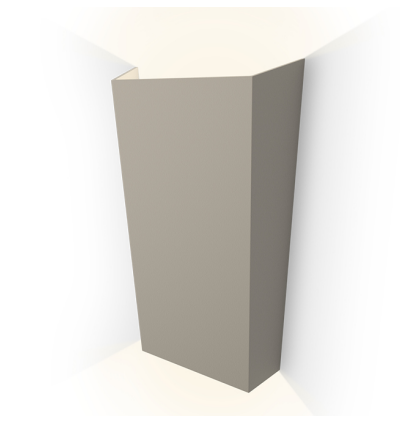
Break Plus outdoor wall lamp. It resembles a tile or a brick, designed to be integrated in the architecture of all types of space. Its geometric shape creates a sense of spatial depth on flat surfaces.

Model Sheet



Finish	 25 Beige D1 NCS S 4005-Y50R
	 95 Primer NCS S 1000-N
	 22 Graphite Black NCS S 8000-N
	 37 Terra Red NCS S 4040-Y70R

LED temperature color 2700 K / 3500 K

Dimming On/ Off

Materials Body: Aluminum
Diffuser: Polycarbonate

Light source 2 x LED 4W 350mA



LED CRI>90 181
2700 K / 3500 K

Driver Constant Current 100~240 V V
50~60 Hz HZ



Application Outdoor lamps

Packaging 1 Box
0.42 m x 0.27 m x 0.11 m
Gross weight 3.2
Net weight 2.2
Vol. 0.0124

Lighting effect

General Lighting

Reduced-height outdoor lamp to shade light on the ground.



Photometric Data

Go to vibia.com to get the photometric data for the different LED color temperatures.

Efficiency	22.47 lm/W
Coordinate System	CG
Total Flux	227.58 lm
Maximum Value	49.55 cd

Other Applications

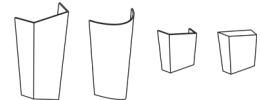

All of our products come with a five-year warranty. Check our legal terms at www.vibia.com/warranty

Vibia Lighting, S.L.U.

Office / Oficina
Progrés 4-6. 08850 Gavà. Barcelona, Spain.

International T +34 934 796 971
Spain / Portugal T +34 934 796 970

customer.service@vibia.com
vibia.com

Break plus

VIBIA





4118

Design By Xuclà

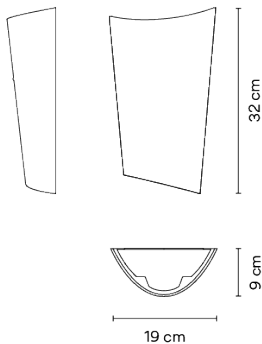
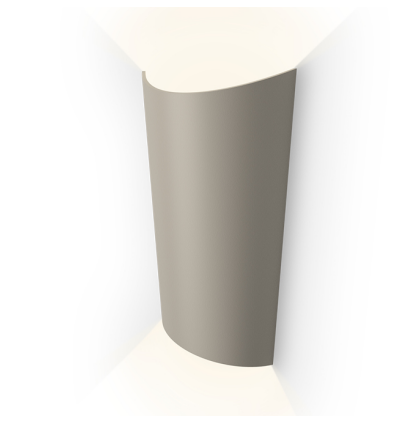
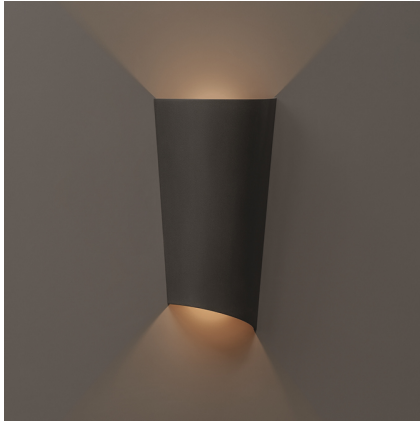
Break Plus outdoor wall lamp. It resembles a tile or a brick, designed to be integrated in the architecture of all types of space, creating a sense of spatial depth. Its light is reflected in two directions.

Model Sheet



Finish	 25 Beige D1 NCS S 4005-Y50R
	 95 Primer NCS S 1000-N
	 22 Graphite Black NCS S 8000-N
	 37 Terra Red NCS S 4040-Y70R

LED temperature color 2700 K / 3500 K

Dimming On/ Off

Materials Body: Aluminum
Diffuser: Polycarbonate

Light source 2 x LED 4W 350mA



LED CRI>90 181
2700 K / 3500 K

Driver Constant Current 350 100~240
V V 50-60 Hz HZ



Application Outdoor lamps

Packaging 1 Box
0.42 m x 0.27 m x 0.11 m
Gross weight 2.71
Net weight 1.71
Vol. 0.0124

Lighting effect

General Lighting

Reduced-height outdoor lamp to shade light on the ground.



Photometric Data

Go to vibia.com to get the photometric data for the different LED color temperatures.

Efficiency	15.31 lm/W
Coordinate System	CG
Total Flux	153.79 lm
Maximum Value	39.63 cd

Other Applications

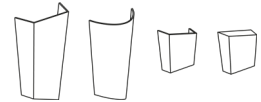

All of our products come with a five-year warranty. Check our legal terms at www.vibia.com/warranty

Vibia Lighting, S.L.U.

Office / Oficina
Progrés 4-6. 08850 Gavà. Barcelona, Spain.

International T +34 934 796 971
Spain / Portugal T +34 934 796 970

customer.service@vibia.com
vibia.com