

FLOS

F0095054 Light Silver Anodized

Aim Small

Designed by Ronan & Erwan Bouroullec, 2014



12W - 725lm - 2700K - CRI> 90

Suspended light fitting. Body in varnished aluminium sheet, shade in photo-etched optical polycarbonate. Internal reflector in photo-etched PC. Directionable body. Powered directly from mains. The LED can be dimmed with a «Triac for Led» dimmer approved by Flos. Flos does not respond in case of wrong electrical connection system installations. The cable has a useful length of 9 metres and thus the lamp can be suspended 3 metres from the ceiling. Multiple rose with capacity to connect up to 5 Aim Small also available.

Are you a professional and your project needs consulting and support?

BOOK AN APPOINTMENT

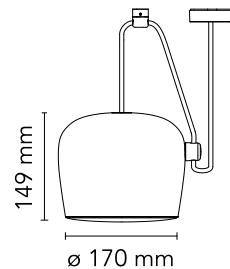

Main specifications

EAN	8059607000113
Mounting	Suspension
Environments	Indoor dry location
Light Source Type	LED
LED type	LED Module
Power (W)	12
System power (W)	12
System flux (lm)	725

Physical

Colour	Light Silver Anodized
Cord length (mm)	9000
Net weight (kg)	1.35
Package height (mm)	310
Package width (mm)	300
Package length (mm)	300
Package volume (m3)	0.03
IP internal	20

Download

Mounting instructions	↓ PDF
Compatible dimmers	↓ PDF
Spare Parts	↓ PDF

Photometric Files

LDT / IES	↓ LDT
-----------	-------

Technical Drawings

2D	↓ ZIP
3D	↓ ZIP
Bim	↓ ZIP



Schematic light drawing

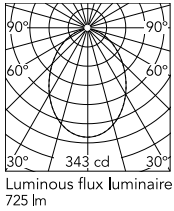

Ecodesign and Energy Labelling

This product contains a light source of energy efficiency class F



Replaceable (LED only)
light source by a
professional

Photometric

Lighting type	Direct
Light distribution	Roto symmetric
CCT (K)	2700
CRI>	90

Electrical

Insulation class	II
Frequency (Hz)	50/60
Main voltage (Vac)	220-240
LED voltage Vf (Vdc)	null
Driver	Integrated
Dimmable	Yes
Dimming type	Mains Cut Dimming
Dimming interface	Remote Dimmable (Dimmer Not Included)
Batteries inside	No

Accessories & Power Supply



OPTIONAL

RF22227

Aim Dimmer



OPTIONAL

F0093030

Aim Multiple Canopy

Spare Parts

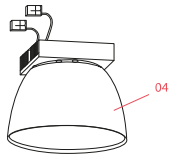
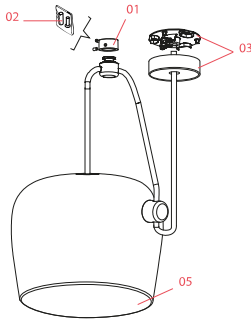

- | | | |
|-----|--|-----------|
| 01. | Natural anodized ceiling attachment assembly | RF0090154 |
| 02. | Kit of quantity 3 m4 screws | RF06750 |
| 03. | Ceiling rose assembly | RF1555030 |
| 05. | Aim small opal diffuser | RF0095500 |

DOWNLOAD



RF0090154
Natural anodized ceiling
attachment assembly



RF06750
Kit of quantity 3 m4 screws



RF1555030
Ceiling rose assembly



RF0095500
Aim small opal diffuser

FLOS

F0090054 Light Silver Anodized

Aim

Designed by Ronan & Erwan Bouroullec, 2013



16W - 895lm - 2700K - CRI> 90

Suspended light fitting. Body in varnished aluminium sheet, shade in photo-etched optical polycarbonate. Internal reflector in photo-etched ABS. Orientable body. Powered directly from mains. The LED can be dimmed with a «Triac for Led» dimmer approved by Flos. Flos does not respond in case of wrong electrical connection system installations. The cable has a useful length of 9 meters and thus the lamp can be suspended 3 meters from the ceiling. Multiple rose with capacity to connect up to 5 Aims also available.

Are you a professional and your project needs consulting and support?

BOOK AN APPOINTMENT

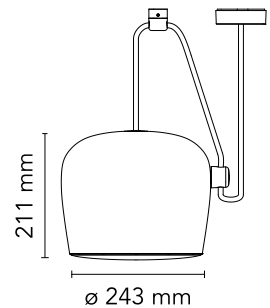

Main specifications

EAN	8059607000076
Mounting	Suspension
Environments	Indoor dry location
Light Source Type	LED
LED type	LED Module
Power (W)	16
System power (W)	16
System flux (lm)	895

Physical

Colour	Light Silver Anodized
Cord length (mm)	9000
Net weight (kg)	3.2
Package height (mm)	375
Package width (mm)	300
Package length (mm)	300
Package volume (m3)	0.03
IP internal	20

Download

Mounting instructions	↓ PDF
Compatible dimmers	↓ PDF
Spare Parts	↓ PDF

Photometric Files

LDT / IES	↓ LDT
-----------	-------

Technical Drawings

2D	↓ ZIP
3D	↓ ZIP
Bim	↓ ZIP



Schematic light drawing

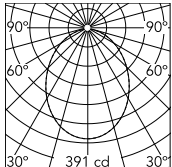

Luminous flux Luminaire
895 lm

Photometric

Lighting type	Direct
Light distribution	Roto symmetric
CCT (K)	2700
CRI>	90

Electrical

Insulation class	II
Frequency (Hz)	50/60
Main voltage (Vac)	220-240
LED voltage Vf (Vdc)	null
Driver	Integrated
Dimmable	Yes
Dimming type	Mains Cut Dimming
Dimming interface	Remote Dimmable (Dimmer Not Included)
Batteries inside	No

Ecodesign and Energy Labelling

This product contains a light source of energy efficiency class F

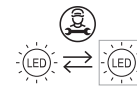

Replaceable (LED only)
light source by a
professional

Accessories & Power Supply



OPTIONAL

RF22227

Aim Dimmer



OPTIONAL

F0093030

Aim Multiple Canopy

Spare Parts

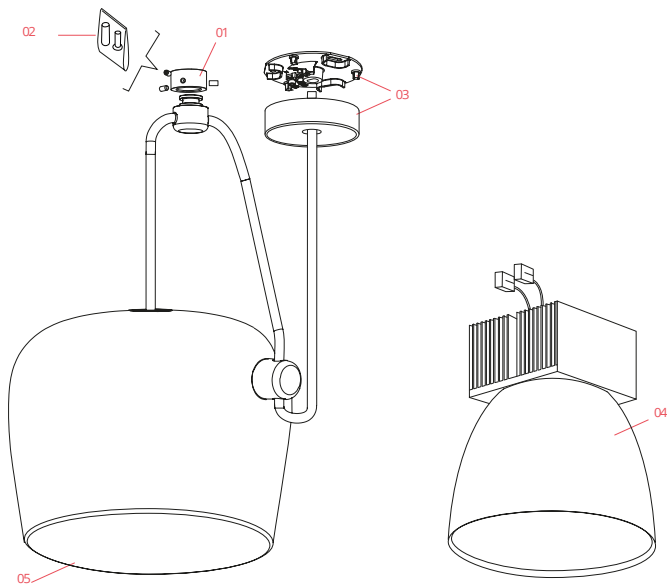

- | | | |
|-----|--|-----------|
| 01. | Natural anodized ceiling attachment assembly | RF0090154 |
| 02. | Kit of quantity 3 m4 screws | RF06750 |
| 03. | Black ceiling rose assembly | RF0090230 |
| 05. | Aim opal diffuser | RF0090600 |

DOWNLOAD



RF0090154
Natural anodized ceiling
attachment assembly



RF06750
Kit of quantity 3 m4 screws



RF0090230
Black ceiling rose assembly



RF0090600
Aim opal diffuser