

# Halo circular

VIBIA

2333





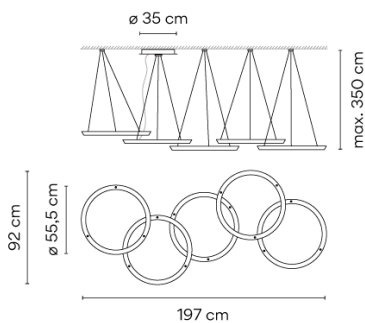

Design By Martín Azúa

HALO is a hanging lamp with circular pieces, which creates subtle, magical lighting. Designed by Martín Azúa, it is available in matt white lacquer.

## Model Sheet



**Optional: Extra cable length**  
Min. quantity, upcharge and extra lead time apply [EN]

<b>Finish</b>	03 White RAL 9016
<b>LED temperature color</b>	2700 K / 3000 K
<b>Dimming</b>	1-10V / Casambi / DALI
<b>Installation type</b>	Surface Canopy
<b>Materials</b>	Diffuser: PMMA Ceiling rose: Steel
<b>LED</b>	 CRI>80 10430 lm 90.69 2700 K / 3000 K
<b>Driver</b>	Constant Voltage 100~277 V V 50~60 Hz HZ
<b>Remarks</b>	1-10V Electronic dimming      
<b>Application</b>	Hanging lamps
<b>Packaging</b>	2 Box 0.6 m x 0.6 m x 0.27 m Gross weight 30.75 Net weight 19.75 Vol. 0.1123

### Lighting effect

#### Volumetric Diffuser

Subtly directed, diffused light that generates a soft hierarchy of light on to the illuminated surface



### Photometric Data

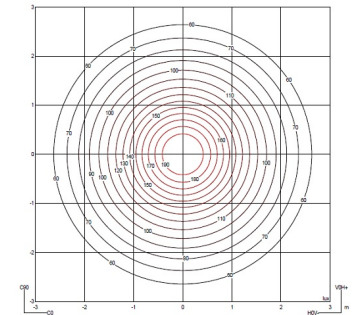
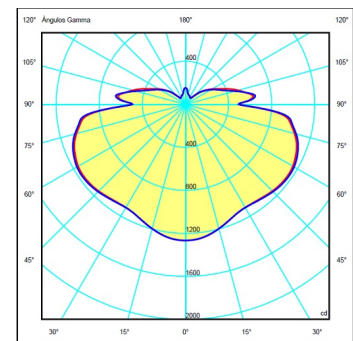

<b>Efficiency</b>	62.72 lm/W
<b>Coordinate System</b>	CG
<b>Total Flux</b>	8643.26 lm
<b>Maximum Value</b>	1266.82 cd

### Other Applications

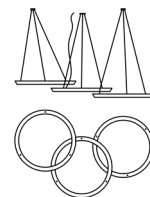

All of our products come with a five-year warranty. Check our legal terms at [www.vibia.com/warranty](http://www.vibia.com/warranty)

Vibia Lighting, S.L.U.

Office / Oficina  
Progrés 4-6. 08850 Gavà. Barcelona, Spain.

International T +34 934 796 971  
Spain / Portugal T +34 934 796 970

customer.service@vibia.com  
vibia.com